

Keysight U8903A Audio Analyzer

Notice: This document contains references to Agilent. Please note that Agilent's Test and Measurement business has become Keysight Technologies. For more information, go to www.keysight.com.

Notices

Copyright Notice

© Keysight Technologies 2009–2016
No part of this manual may be reproduced in any form or by any means (including electronic storage and retrieval or translation into a foreign language) without prior agreement and written consent from Keysight Technologies as governed by United States and international copyright laws.

Manual Part Number

U8903-90006

Edition

Edition 7, April 1, 2016

Printed in:

Printed in Malaysia

Published by:

Keysight Technologies
Bayan Lepas Free Industrial Zone,
11900 Penang, Malaysia

Technology Licenses

The hardware and/or software described in this document are furnished under a license and may be used or copied only in accordance with the terms of such license.

Declaration of Conformity

Declarations of Conformity for this product and for other Keysight products may be downloaded from the Web. Go to <http://www.keysight.com/go/conformity>. You can then search by product number to find the latest Declaration of Conformity.

U.S. Government Rights

The Software is “commercial computer software,” as defined by Federal Acquisition Regulation (“FAR”) 2.101. Pursuant to FAR 12.212 and 27.405-3 and Department of Defense FAR Supplement (“DFARS”) 227.7202, the U.S. government acquires commercial computer software under the same terms by which the software is customarily provided to the public. Accordingly, Keysight provides the Software to U.S. government customers under its standard commercial license, which is embodied in its End User License Agreement (EULA), a copy of which can be found at <http://www.keysight.com/find/sweula>. The license set forth in the EULA represents the exclusive authority by which the U.S. government may use, modify, distribute, or disclose the Software. The EULA and the license set forth therein, does not require or permit, among other things, that Keysight: (1) Furnish technical information related to commercial computer software or commercial computer software documentation that is not customarily provided to the public; or (2) Relinquish to, or otherwise provide, the government rights in excess of these rights customarily provided to the public to use, modify, reproduce, release, perform, display, or disclose commercial computer software or commercial computer software documentation. No additional government requirements beyond those set forth in the EULA shall apply, except to the extent that those terms, rights, or licenses are explicitly required from all providers of commercial computer software pursuant to the FAR and the DFARS and are set forth specifically in writing elsewhere in the EULA. Keysight shall be under no obligation to update, revise or otherwise modify the Software. With respect to any technical data as defined by FAR 2.101, pursuant to FAR 12.211 and 27.404.2 and DFARS 227.7102, the U.S. government acquires no greater than Limited Rights as defined in FAR 27.401 or DFAR 227.7103-5 (c), as applicable in any technical data.

Warranty

THE MATERIAL CONTAINED IN THIS DOCUMENT IS PROVIDED “AS IS,” AND IS SUBJECT TO BEING CHANGED, WITHOUT NOTICE, IN FUTURE EDITIONS. FURTHER, TO THE MAXIMUM EXTENT PERMITTED BY APPLICABLE LAW, KEYSIGHT DISCLAIMS ALL WARRANTIES, EITHER EXPRESS OR IMPLIED, WITH REGARD TO THIS MANUAL AND ANY INFORMATION CONTAINED HEREIN, INCLUDING BUT NOT LIMITED TO THE IMPLIED WARRANTIES OF MERCHANTABILITY AND FITNESS FOR A PARTICULAR PURPOSE. KEYSIGHT SHALL NOT BE LIABLE FOR ERRORS OR FOR INCIDENTAL OR CONSEQUENTIAL DAMAGES IN CONNECTION WITH THE FURNISHING, USE, OR PERFORMANCE OF THIS DOCUMENT OR OF ANY INFORMATION CONTAINED HEREIN. SHOULD KEYSIGHT AND THE USER HAVE A SEPARATE WRITTEN AGREEMENT WITH WARRANTY TERMS COVERING THE MATERIAL IN THIS DOCUMENT THAT CONFLICT WITH THESE TERMS, THE WARRANTY TERMS IN THE SEPARATE AGREEMENT SHALL CONTROL.

Safety Information

CAUTION

















A CAUTION notice denotes a hazard. It calls attention to an operating procedure, practice, or the like that, if not correctly performed or adhered to, could result in damage to the product or loss of important data. Do not proceed beyond a CAUTION notice until the indicated conditions are fully understood and met.

WARNING

A WARNING notice denotes a hazard. It calls attention to an operating procedure, practice, or the like that, if not correctly performed or adhered to, could result in personal injury or death. Do not proceed beyond a WARNING notice until the indicated conditions are fully understood and met.

Safety Symbols

The following symbols on the instrument and in the documentation indicate precautions which must be taken to maintain safe operation of the instrument.

	Direct current (DC)		Equipment protected throughout by double insulation or reinforced insulation
	Alternating current (AC)		Off (supply)
	Both direct and alternating current		On (supply)
	Three-phase alternating current		Caution, risk of electric shock
	Earth (ground) terminal		Caution, risk of danger (refer to this manual for specific Warning or Caution information)
	Protective conductor terminal		Caution, hot surface
	Frame or chassis terminal		Out position of a bi-stable push control
	Equipotentiality		In position of a bi-stable push control

General Safety Information

The following general safety precautions must be observed during all phases of operation of this instrument. Failure to comply with these precautions or with specific warnings elsewhere in this manual violates safety standards of design, manufacture, and intended use of the instrument. Keysight Technologies assumes no liability for the customer's failure to comply with these requirements.

WARNING

- Ground the equipment.
For Safety Class 1 equipment (equipment having a protective earth terminal), an uninterruptible safety earth ground must be provided from the mains power source to the product input wiring terminals or supplied power cable.
 - DO NOT operate the product in an explosive atmosphere or in the presence of flammable gases or fumes.
For continued protection against fire, replace the line fuse(s) only with fuse(s) of the same voltage and current rating and type. DO NOT use repaired fuses or short-circuited fuse holders.
 - Keep away from live circuits.
Operating personnel must not remove equipment covers or shields. Procedures involving the removal of covers or shields are for use by service-trained personnel only. Under certain conditions, dangerous voltages may exist even with the equipment switched off. To avoid dangerous electric shock, DO NOT perform procedures involving cover or shield removal unless you are qualified to do so.
 - DO NOT operate damaged equipment.
If the built-in safety protection features have been impaired through physical damage, excessive moisture, or any other reason, REMOVE POWER and do not use product until safe operation is verified by service-trained personnel. If necessary, return the product to Keysight for service and repair to ensure that the safety features are maintained.
 - DO NOT service or adjust alone.
Do not attempt any internal service or adjustment unless a person capable of rendering first aid and resuscitation is present.
-

WARNING

- DO NOT substitute parts or modify equipment.
To avoid the occurrence of additional hazards, do not install substitute parts or perform any unauthorized modification to the product. Return the product to Keysight for service or repair to ensure that the safety features are maintained.
- This equipment is under CAT 1 measurement category, do not connect the cable to MAIN.



CAT 1

Maximum Working Voltage: 200 Vp for
altitude up to 3000 m

Maximum Transient Voltage: 1210 V

- Do not measure more than the rated voltage (as marked on the equipment).
-

CAUTION

- Use the device with the cables provided.
 - Repair or service that is not covered in this manual should only be performed by qualified personnels.
 - Observe all markings on the device before establishing any connection.
 - Always use dry cloth to clean the device. Do not use ethyl alcohol or any other volatile liquid to clean the device.
 - Do not permit any blockage of the ventilation holes of the device.
-

Environmental Conditions

This instrument is designed for indoor use and in an area with low condensation. The table below shows the general environmental requirements for this instrument.





Environmental condition	Requirement
Operating temperature	0 °C to 55 °C
Operating humidity	20% to 80% RH noncondensing at 40 °C
Storage temperature	-40 °C to 70 °C
Storage humidity	20% to 80% RH noncondensing at 65 °C

CAUTION

The U8903A Audio Analyzer complies with the following safety and EMC requirements.

- IEC 61010-1:2001/EN 61010-1:2001 (2nd Edition)
 - Canada: CAN/CSA-C22.2 No. 61010-1-04
 - Canada: ICES-001:2004
 - IEC 61326-1:2005/EN 61326-1:2006
 - Australia/New Zealand: AS/NZS CISPR11:2004
 - USA: ANSI/UL 61010-1:2004
-

Regulatory Markings

 <p>The CE mark is a registered trademark of the European Community. This CE mark shows that the product complies with all the relevant European Legal Directives.</p>	 <p>The RCM mark is a registered trademark of the Spectrum Management Agency of Australia. This signifies compliance with the Australia EMC Framework regulations under the terms of the Radio Communication Act of 1992.</p>
<p>ICES/NMB-001</p> <p>ICES/NMB-001 indicates that this ISM device complies with the Canadian ICES-001. Cet appareil ISM est conforme a la norme NMB-001 du Canada.</p>	 <p>This instrument complies with the WEEE Directive (2002/96/EC) marking requirement. This affixed product label indicates that you must not discard this electrical or electronic product in domestic household waste.</p>
 <p>The CSA mark is a registered trademark of the Canadian Standards Association.</p>	

Waste Electrical and Electronic Equipment (WEEE) Directive 2002/96/EC

This instrument complies with the WEEE Directive (2002/96/EC) marking requirement. This affixed product label indicates that you must not discard this electrical or electronic product in domestic household waste.

Product category:

With reference to the equipment types in the WEEE directive Annex 1, this instrument is classified as a “Monitoring and Control Instrument” product.

The affixed product label is as shown below.



Do not dispose in domestic household waste.

To return this unwanted instrument, contact your nearest Keysight Service Center, or visit <http://about.keysight.com/en/companyinfo/environment/takeback.shtml> for more information.

Sales and Technical Support

To contact Keysight for sales and technical support, refer to the support links on the following Keysight websites:

- www.keysight.com/find/U8903A
(product-specific information and support, software and documentation updates)
- www.keysight.com/find/assist
(worldwide contact information for repair and service)

In This Guide...

1 Overview of the U8903A

This chapter provides a general overview of the U8903A, which includes the initial inspection and product outlook.

2 Basic Operations of the U8903A

This chapter gets you started with the basic operation of the U8903A.

3 Using the U8903A as an Audio Generator and Analyzer

This chapter guides you through the configuration of the U8903A audio generator and analyzer settings. Measurement examples on using the generator and analyzer functions are also provided.

4 Performing Frequency and Time Domain Analysis and Sweep

This chapter describes how to configure the U8903A frequency and time domain settings, as well as sweep function. The common graph functions are also explained in this chapter.

5 File Maintenance

This chapter provides the information on how to save and recall the instrument state.

Appendixes

THIS PAGE HAS BEEN INTENTIONALLY LEFT BLANK.

Table of Contents

Safety Symbols	3
General Safety Information	4
Environmental Conditions	6
Regulatory Markings	7
Waste Electrical and Electronic Equipment (WEEE) Directive	
2002/96/EC	8
Product category:	8
Sales and Technical Support	8
In This Guide...	9
1 Overview of the U8903A	
Introduction	18
LXI Class-C Compliant Audio Analyzer	19
Initial Inspection	20
Standard accessories	20
Optional accessories	20
Initial check	21
Product Overview	22
Front panel	22
Rear panel	25
2 Basic Operations of the U8903A	
Powering On the U8903A	28
Presetting the U8903A	29
Enabling the Help Function	30
Performing Basic Self-Test on the U8903A	30
Entering/Editing the Parameter Values	31
Enabling the Run/Stop and On/Off Modes	32
Enabling the I/O Configuration	32
Configuring the GPIB address	32

	Configuring the LAN settings	33
3	Using the U8903A as an Audio Generator and Analyzer	
	Accessing the Generator/Analyzer Menu	36
	Configuring the Output Settings	37
	Generating a Waveform	38
	Setting Up the Input and Common Settings	40
	Selecting the Measurement Functions	43
	Measurement Examples	47
4	Performing Frequency and Time Domain Analysis and Sweep	
	Performing Frequency and Time Domain Analysis	60
	Performing Sweep	65
	Using the Graph Functions	71
5	File Maintenance	
	Saving the Instrument State to a File	76
	Recalling the Instrument State from a File	77
	Appendixes	
	Generator Menu Tree	80
	Analyzer Menu Tree	83
	Time Domain and Frequency Domain Menu Trees	86
	Sweep Menu Tree	87
	System Menu Tree	88

List of Figures

Figure 1-1	U8903A front panel	22
Figure 1-2	U8903A rear panel	25
Figure 2-1	Self-test selection	30
Figure 2-2	GPIB address configuration	32
Figure 2-3	Automatic configuration of the LAN settings	33
Figure 2-4	Manual configuration of the LAN settings	34
Figure 3-1	Generator menu	36
Figure 3-2	Analyzer menu	36
Figure 3-3	Output type selection	37
Figure 3-4	Analyzer input settings menu	40
Figure 3-5	Analyzer common settings menu	42
Figure 3-6	Function 1 measurement function selection	44
Figure 3-7	Function 2 measurement function selection first page	44
Figure 3-8	Function 2 measurement function selection second page	45
Figure 3-9	Function 2 measurement function selection third page	45
Figure 3-10	Function 2 measurement function selection fourth page	46
Figure 3-11	Sine waveform configuration	47
Figure 3-12	Voltage measurement	48
Figure 3-13	Dual waveform menu first page	49
Figure 3-14	Dual waveform menu second page	50
Figure 3-15	Dual sine waveform configuration	50
Figure 3-16	THD + N Ratio measurement (amplitude ratio of 1%)	51
Figure 3-17	Variable phase waveform menu	53
Figure 3-18	Variable phase waveform configuration	54
Figure 3-19	Phase difference measurement	55
Figure 3-20	Crosstalk (channel driven) measurement	56
Figure 3-21	Sine waveform configuration	57
Figure 3-22	Crosstalk (channel driven) measurement	58
Figure 4-1	Frequency domain mode	60
Figure 4-2	Time domain mode	61

Figure 4-3	Monitor settings configuration	61
Figure 4-4	Axis settings configuration	62
Figure 4-5	Input and trigger settings configuration	63
Figure 4-6	Harmonics display	64
Figure 4-7	Sweep menu first page	65
Figure 4-8	Sweep menu second page	66
Figure 4-9	Sweep settings configuration	67
Figure 4-10	Axis settings configuration	68
Figure 4-11	I/O settings configuration	69
Figure 4-12	List View	69
Figure 4-13	Peak Search menu	71
Figure 4-14	Marker menu first page	72
Figure 4-15	Marker menu second page	73
Figure 4-16	Marker → menu	73
Figure 4-17	Full screen	74
Figure 5-1	File Manager menu for saving the U8903A state	76
Figure 5-2	File Manager menu for recalling the U8903A state	77

List of Tables

Table 1-1	U8903A front panel description	22
Table 1-2	U8903A rear panel description	25
Table 2-1	Power cord types	28
Table 3-1	Measurement functions	43

THIS PAGE HAS BEEN INTENTIONALLY LEFT BLANK.

1 Overview of the U8903A

Introduction	18
LXI Class-C Compliant Audio Analyzer	19
Initial Inspection	20
Product Overview	22

This chapter explains how to perform an initial inspection of your U8903A audio analyzer and provides an overview of its front and rear panel functions.

Introduction

The U8903A is a powerful, multichannel audio measurement system that combines both generator and analyzer.

The U8903A standard features include the following:

- Audio generator covering the frequency range of 5 Hz to 80 kHz. Its sine waveform amplitude range is within 0 Vrms to 8 Vrms (11.3 Vp) for the Unbalanced or Common mode test output configuration, and 0 Vrms to 16 Vrms (22.6 Vp) for the Balanced output configuration.
- Audio analyzer covering the frequency range of 10 Hz to 100 kHz and amplitude range of microvolts to 200 Vp (140 Vrms)
- Graph display of the time and frequency domain views of the signal
- Voltage, frequency, and phase sweep capability
- GPIB, LAN, and USB remote interface

Using the generator mode, you can generate not only a basic sine waveform, but also square, dual sine, variable phase, noise, DC, multitone, and arbitrary waveforms.

The analyzer mode enables you to perform a wide range of audio measurements consisting of voltage, frequency, THD + N, SINAD, SNR and noise level, SMPTE intermodulation distortion, difference frequency distortion (DFD), phase, and crosstalk.

NOTE

- Refer to the *U8903A Audio Analyzer User's Guide* for more details.
 - To search for software/firmware updates for your product, go to the Keysight Technical Support website at www.keysight.com/find/TechSupport.
 - Refer to “**Appendixes**” on page 79 for the generator, analyzer, frequency domain and time domain, sweep, and system menu trees.
-

LXI Class-C Compliant Audio Analyzer



The U8903A audio analyzer is an **LXI Class C** compliant instrument, developed using LXI Technology. LXI, an acronym for LAN eXtension for Instrumentation, is an instrument standard for devices that use the Ethernet (LAN) as their primary communication interface.

Hence, it is easy-to-use instrument especially with the usage of an integrated Web browser that provides a convenient way to configure the instrument's functionality.

Initial Inspection

Standard accessories

Verify the following standard purchase items. If anything is missing or damaged, please contact the nearest Keysight Sales Office.

- Power cord
- Shielded LAN cable
- USB cable
- USB flash storage device
- Keysight U8903A Audio Analyzer Quick Start Guide
- Keysight U8903A Audio Analyzer Product Reference CD-ROM
- Certificate of Calibration

Optional accessories

The following accessories are available for purchase separately.

- BNC male to BNC male cable, 1.2 m, jade gray
- BNC male to RCA male cable, 2 m, black
- XLR male to XLR female cable, 2 m, black
- Rack mount kit
- BNC cable for trigger connection

Initial check

When you receive your U8903A, inspect the unit for any obvious damage that may occur during shipment. If any damage is found, contact the nearest Keysight Sales Office immediately. Keep the original packaging in case the purchased U8903A has to be returned to Keysight in future.

The U8903A can operate within the temperature range of 0 °C to 55 °C. Ensure that the U8903A is installed in a location that allows sufficient space at the top, sides, and rear for adequate air circulation.

The U8903A can be mounted in a standard 19-inch rack panel or cabinet. Rack mount kits are available as Option 908. Support rails are also required for rack mounting. These are normally supplied with the cabinet and are not included with the rack mount options.

If you are installing an instrument on top of the U8903A, ensure that the instrument does not obstruct the ventilation holes at the top side of the U8903A. If required, use a filler panel above the U8903A to ensure adequate space for air circulation.

Product Overview

Front panel

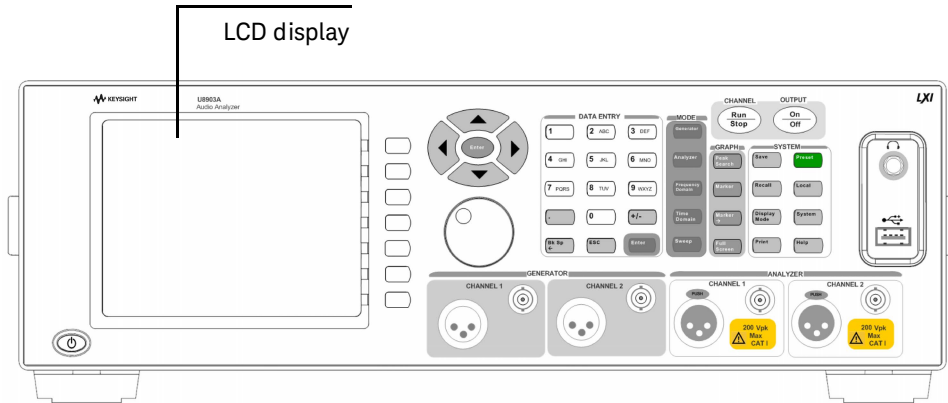

Figure 1-1 U8903A front panel

Table 1-1 U8903A front panel description









LCD display	Provides information on the current function including status indicators, settings, and error messages
Key	Description
Power on/off	Turns the U8903A on or off
	
Softkeys 1 to 7	Activates the function as displayed on the right side of the LCD display. To select a function, press the corresponding softkey.
	
	
	
	
	
	
	

Table 1-1 U8903A front panel description (continued)





Key	Description
<p>Enter and arrow keys</p> 	<p>The Enter key confirms and then terminates data entry when the default unit is used. Press the arrow keys to do the following:</p> <ul style="list-style-type: none"> - select a channel - increase or decrease a highlighted digit or value of the current measurement selection - navigate the Help topics - navigate within forms used for setting up measurements - navigate within tables
<p>Data Entry</p> 	<p>Contains alphanumeric and editing keys. Press the alphanumeric keys to enter the measurement values or text, or select the channel number in analyzer mode. Use the editing keys to modify the values or data and confirm an entry.</p>
<p>Mode</p> 	<p>Enables access to the U8903A core functions comprising generator, analyzer, graph(frequency domain and time domain), and sweep. To select a function, press the corresponding key.</p>
<p>Graph</p> 	<p>Enables access to the graph functions including peak navigation and marker function. You can also use the Full Screen function to maximize the display area. To select a graph function, press the corresponding key.</p>

Table 1-1 U8903A front panel description (continued)



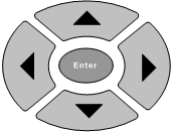

Key	Description
<p>System</p> 	<p>Controls system-wide functions consisting of:</p> <ul style="list-style-type: none"> – instrument configuration information and I/O setup – screen capture function, which prints the display to a file on a USB external flash storage – display mode, which toggles between the number of channels to show on the LCD display – save and recall – local key, which switches from remote mode to front panel access – instrument preset and help function <p>To select any of the above functions, press the corresponding key.</p>
<p>Channel/Output</p> 	<p>Toggle the Run/Stop key to start or stop signal generation or measurements for the selected generator or analyzer channel respectively.</p> <p>The On/Off key toggles on or off the generator output for all channels.</p>
<p>Control</p> <p>Knob</p> 	<p>Rotate the knob to increase or decrease a numeric value, change a highlighted digit or character, step through a list, or move the markers along the graph plot</p>
<p>Connector</p> <p>Generator output</p> 	<p>Description</p> <p>Outputs an audio signal to the unit-under-test (UUT). A XLR male output connector and a BNC female output connector are provided for each channel.</p>
<p>Analyzer input</p> 	<p>Accepts an audio signal from the UUT. A XLR female input connector and a BNC female input connector are provided for each channel.</p>

Table 1-1 U8903A front panel description (continued)

Connector	Description
USB host and headphone jack	Use the USB host to connect a USB external flash storage for data transfer. You can connect or disconnect the USB external flash storage without shutting down or restarting the U8903A. The headphone jack will only be applicable in future releases.

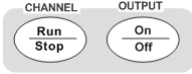

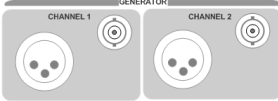
Rear panel

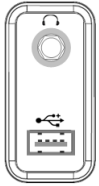
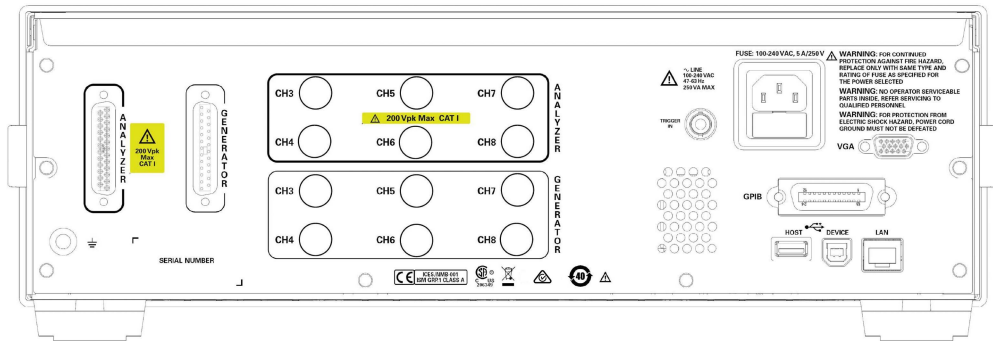
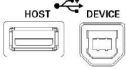
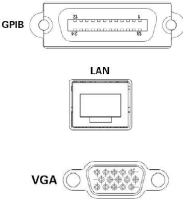
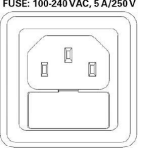



Figure 1-2 U8903A rear panel

Table 1-2 U8903A rear panel description

Connector	Description
DSub analyzer input and generator output	25-pin Balanced input and output signal connectors for channels 3 to 8. Only available in future releases.
BNC input and output	Unbalanced input and output signal connectors for channels 3 to 8. Only available in future releases.

Table 1-2 U8903A rear panel description (continued)

Connector	Description
<p>USB host and device</p> 	<p>The USB host is used to connect a USB external flash storage. The USB device allows communication with the PC via a USB cable.</p>
<p>GPIB, LAN, and VGA interfaces</p> 	<p>The GPIB interface is a General Purpose Interface Bus (IEEE-488) standard interface. The LAN interface allows Ethernet LAN communication through a 10/100 Base-T LAN cable. Recommended to use a shielded LAN cable. The VGA interface allows the U8903A to be connected to an external monitor.</p>
<p>Fuse and AC power</p> 	<p>Fuse compartment for AC supply. AC power receptacle for AC line voltage connection.</p>
<p>Trigger in</p> 	<p>A BNC connector to receive an external TTL or CMOS signal for triggering operation. Triggering can occur on either the positive or negative edge.</p>

2 Basic Operations of the U8903A

Powering On the U8903A	28
Presetting the U8903A	29
Enabling the Help Function	30
Performing Basic Self-Test on the U8903A	30
Entering/Editing the Parameter Values	31
Enabling the Run/Stop and On/Off Modes	32
Enabling the I/O Configuration	32

This chapter explains how to perform the U8903A basic operations such as power-on, preset, self-test, enabling the help function, using the editing keys, run or stop the measurements, as well as configuring the I/O settings.

Powering On the U8903A

Connect one end of the power cord to the U8903A rear panel AC power inlet, and the other end to an AC voltage source. Ensure that the provided power cord matches the country of origin as shown in the following table. The U8903A will automatically adjust to the correct line voltage in the range of 100 Vac to 240 Vac.

WARNING

Always use a grounded power cord.

Table 2-1 Power cord types















Plug type	Cable part number	Plug type	Cable part number
Opt 900 (U.K.) 	8120-1703	Opt 918 (Japan) 	8120-4754
Opt 901 (Australia) 	8120-0696	Opt 919 (Israel) 	8120-6799
Opt 902 (Europe) 	8120-1692	Opt 920 (Argentina) 	8120-6871
Opt 903 (U.S.A.) 	8120-1521	Opt 921 (Chile) 	8120-6979
Opt 906 (Switzerland) 	8120-2296	Opt 922 (China) 	8120-8377

Table 2-1 Power cord types (continued)

Plug type	Cable part number	Plug type	Cable part number
Opt 912 (Denmark)	8120-2957	Opt 927 (Thailand)	8120-8871
			
Opt 917 (South Africa)	8120-4600		
			

To turn on the U8903A, press  located on the lower left corner of the front panel. Press  again to turn off the U8903A.

Presetting the U8903A

To preset the U8903A to its factory default settings, you can perform either one of the following steps.

- Send the ***RST**, **SYSTem:PRESet**, **SYSTem:RESet[:MODE]**, or **SYSTem:RESet:CHANnel** SCPI commands from the PC via the USB, GPIB, or LAN interface.
- Press  on the System panel.

NOTE

In default setting, the HP8903B mode is enabled. For more information on the HP8903B mode, refer to the U8903A Audio Analyzer Instrument Help File.

Enabling the Help Function

To activate the help function, press . To deactivate, press .

NOTE

When Help is enabled, the function keys will not execute their normal functions when pressed.

Performing Basic Self-Test on the U8903A

You can choose to perform either a complete or customized self-test on the U8903A. To access the self-test menu, do the following:

- 1 Press  on the System panel.
- 2 Press **Service > Self-Test** to access the self-test selection.

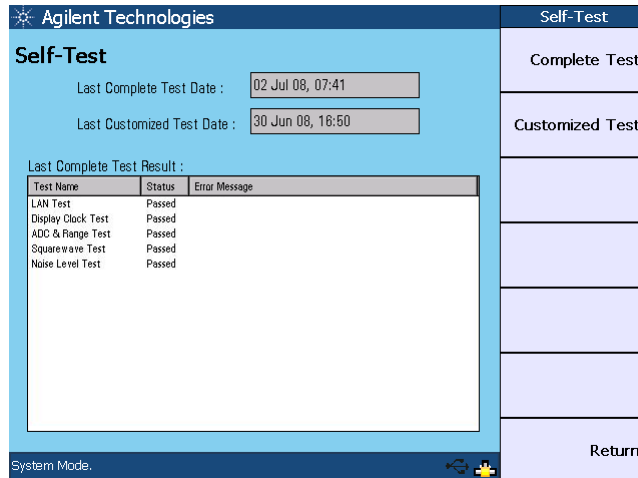







Figure 2-1 Self-test selection

Select **Complete Test** to perform a full instrument self-test or **Customized Test** to perform a self-test on a particular section of the U8903A.

Entering/Editing the Parameter Values

To set or modify the parameter values for measurement, use any of the following methods.

- Use the number keys and decimal point on the Data Entry panel to enter alphanumeric data.
- Press either  on the Data Entry panel or the Enter key in  to confirm an entry.
- Press  on the Data Entry panel to specify a positive or negative value.
- Press  on the Data Entry panel to cancel a selected action.
- Press  on the Data Entry panel to delete the character to the left of the cursor.
- Use  to select a channel, and highlight or navigate the editable items on the LCD display for editing.
- Rotate the knob to increase or decrease a numeric value, change a highlighted digit or character, or step through lists or items in a row.

Enabling the Run/Stop and On/Off Modes

Toggle  on the front panel to start or stop signal generation on a generator channel or measurements on an analyzer channel.

When the selected analyzer channel is in Run mode, the U8903A will take continuous readings as fast as possible based on the specified measurement time. Pressing  while in the Run mode will stop the measurements for the selected analyzer channel.

Toggle  on the front panel to turn on or off the generator output for all active channels.

Enabling the I/O Configuration

Configuring the GPIB address

To modify the GPIB address, follow the procedure below.

- 1 Press  on the System panel.
- 2 Press **I/O > GPIB Address** to set the address from 0 to 30.

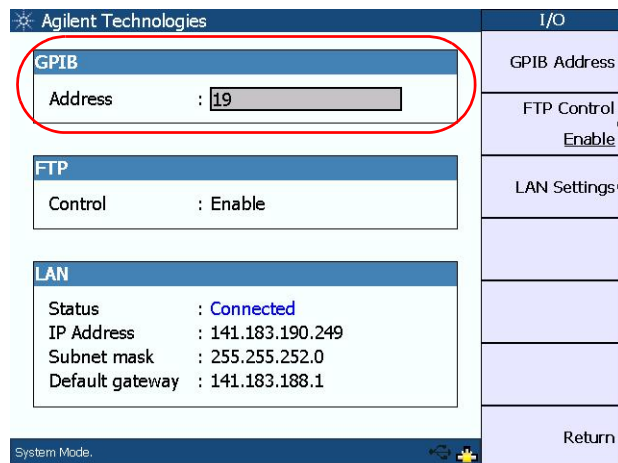

Figure 2-2 GPIB address configuration

Configuring the LAN settings

To configure the LAN settings, do the following:

- 1 Press **System** on the System panel.
- 2 Press **I/O > LAN Settings** to access the LAN settings menu.
- 3 Press **Configure Mode** and select **Automatic** or **Manual**.
 - Select **Automatic** to enable the Dynamic Host Configuration Protocol (DHCP) for the U8903A to obtain an IP address from a DHCP server. The DHCP server will assign a dynamic IP address, subnet mask, and default gateway for the U8903A.
 - Select **Manual** to assign a static IP address, subnet mask, and default gateway for the U8903A.

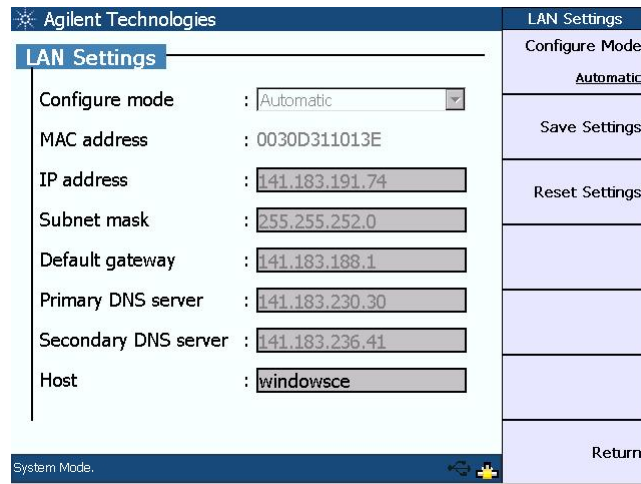

Figure 2-3 Automatic configuration of the LAN settings

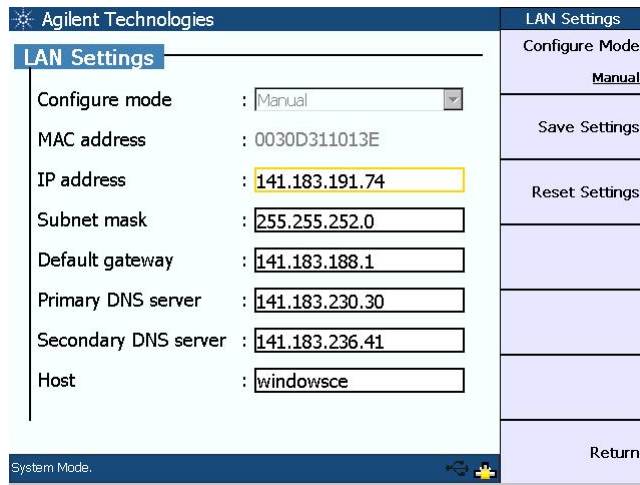

Figure 2-4 Manual configuration of the LAN settings

3 Using the U8903A as an Audio Generator and Analyzer

Accessing the Generator/Analyzer Menu	36
Configuring the Output Settings	37
Generating a Waveform	38
Setting Up the Input and Common Settings	40
Selecting the Measurement Functions	43
Measurement Examples	47

This chapter describes how to configure the U8903A generator and analyzer settings.

Accessing the Generator/Analyzer Menu

To access the generator or analyzer menu, press **Generator** or **Analyzer** on the Mode panel respectively.

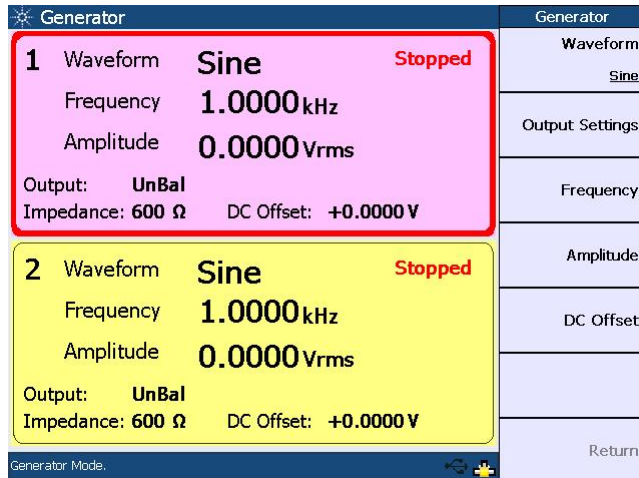

Figure 3-1 Generator menu

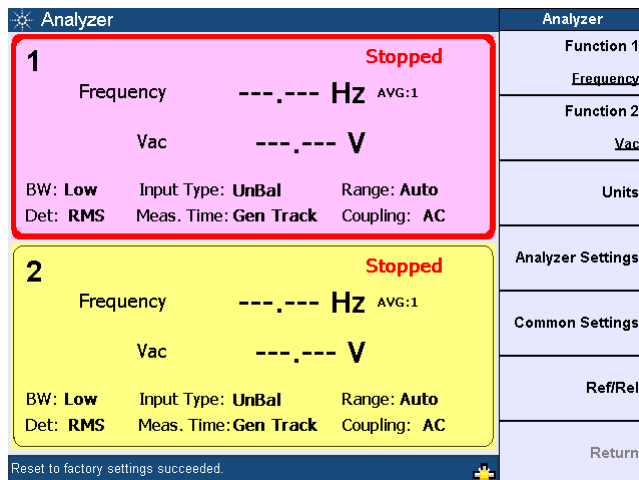

Figure 3-2 Analyzer menu

Select the active channel to start configuring the channel by using the arrow keys.

Configuring the Output Settings

The U8903A allows you to set the output connection and impedance. To configure the output settings, perform the following steps.

- 1 Press **Generator** on the Mode panel to access the Generator menu.
- 2 Press **Output Settings > Output Type** to select the output connection of either Balanced, Unbalanced, or Common mode for the selected channel.

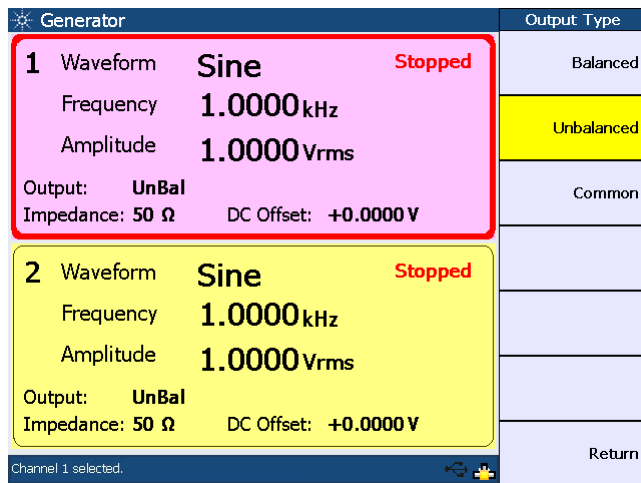

Figure 3-3 Output type selection



- 3 Press **Output Settings > Impedance** to set the output impedance value. The selectable values are 50 Ω and 600 Ω for the Unbalanced output, or 100 Ω and 600 Ω for the Balanced and Common mode outputs.
- 4 Press **Output Settings > Ref. Imp** to set the reference impedance value. The impedance is used for conversion of the measurement result in unit W or dBm.

Generating a Waveform

You can select various waveform types to be generated as well as configure the waveform settings. The available waveform types are listed as follows:

- Sine
- Variable phase
- Dual sine
 - Dual
 - SMPTE IMD 1 to 1
 - SMPTE IMD 4 to 1
 - SMPTE IMD 10 to 1
 - DFD IEC 60118
 - DFD IEC 60268
- Noise
 - Gaussian
 - Rectangular
- DC
- Multitone
- Square
- Arbitrary

To generate a waveform, for example a basic sine waveform, follow the procedure below.

- 1 Press  on the Mode panel to access the Generator menu.
- 2 To access the generator default settings, you may preset the generator mode by pressing  on the System panel. Press **Generator** to preset the generator mode to its default settings.

The default settings are listed as follows.

- Waveform: Sine
- Frequency: 1 kHz
- Amplitude: 0 Vrms
- Output: Unbalanced
- Impedance: 600 Ω
- DC offset: 0 V

- 3** To generate a sine waveform with the default settings, go to Step **9**, else proceed with the following steps.
- 4** Press **Output Settings > Output Type** to select the output connection of either Balanced, Unbalanced, or Common mode for the selected channel.
- 5** Press **Output Settings > Impedance** to set the output impedance value for the selected output connection type.
- 6** Press **Frequency** to set the waveform frequency value for the selected channel.
- 7** Press **Amplitude** to set the waveform amplitude value for the selected channel.
- 8** Press **DC Offset** to set the DC offset value for the selected channel.
- 9** Press  to start the signal generation on the selected channel.

Setting Up the Input and Common Settings

The U8903A enables you to configure the following analyzer input settings for measurement on a selected channel.

- AC/DC coupling
- AC level detector
- Digital filters
- Input connection
- Input ranging
- Frequency lock

The analyzer common settings consist of measurement bandwidth, measurement time, and trigger source. These settings apply to all channels.

To configure the analyzer input settings for measurement on a selected channel, use the following procedure.

- 1 Press **Analyzer** on the Mode panel to access the Analyzer menu, and use the arrow keys to select a channel to be measured.
- 2 Press **Analyzer Settings** to access the analyzer input settings menu.

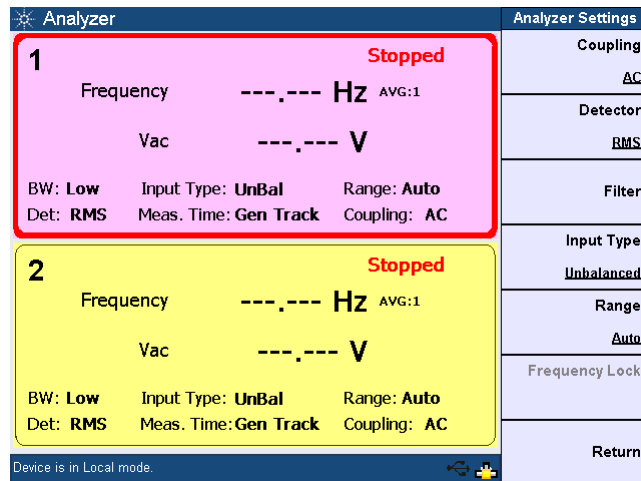

Figure 3-4 Analyzer input settings menu

- 3 Press **Coupling** to select either AC or DC coupling for the selected channel.
- 4 Press **Detector** to select either the RMS, Peak-to-Peak, or Quasi Peak detector for the selected channel.
- 5 Press **Filter** to select either low pass, high pass, or weighting filter, or no filter for the selected channel. You may also select any combination of low pass, high pass, and weighting filters.
- 6 Press **Input Type** to select either Balanced or Unbalanced input connection for the selected channel.
- 7 Press **Range** to select either autorange or one of the following fixed input ranges for the selected channel: 400 mV, 800 mV, 1.6 V, 3.2 V, 6.4 V, 12.8 V, 25 V, 50 V, 100 V, or 140 V.
- 8 Press **Frequency Lock** to select either Auto or Gen. Lock for the fundamental frequency lock type.

NOTE

The fundamental frequency lock setting is only applicable when Function 2 measurement of the specified channel is set to SINAD, THD + N Ratio, or THD + N Level.

3 Using the U8903A as an Audio Generator and Analyzer

To configure the analyzer common settings, use the following procedure.

- 1 Press **Analyzer** on the Mode panel to access the Analyzer menu.
- 2 Press **Common Settings** to access the analyzer common settings menu.

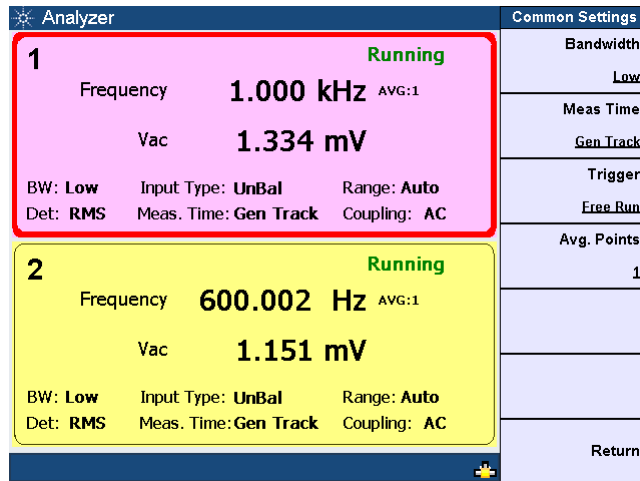

Figure 3-5 Analyzer common settings menu

- 3 Press **Band width** to select either high or low measurement bandwidth for all channels.
- 4 Press **Meas Time** to select the measurement time for all channels.
- 5 Press **Trigger** to set the trigger source as either Free Run or External for all channels. If you are connecting an external trigger source to the Trigger In connector of the U8903A rear panel, then you need to set the trigger source as External from the default Free Run.
- 6 Press **Avg. Points** to set the number of readings used for averaging.

Selecting the Measurement Functions

Each U8903A channel can perform two measurement functions simultaneously. The measurement functions are grouped under Function 1 and Function 2. Function 1 represents the first measurement function whereas Function 2 represents the second measurement function.

Table 3-1 Measurement functions

Function 1	Function 2
Frequency	Frequency
Vac	Vac
Vdc	Vdc
	SNR
	Noise Level
	SINAD
	THD + N Ratio
	THD + N Level
	Crosstalk (channel driven)
	Crosstalk (channel measured)
	SMPTE IMD
	DFD IEC 60268 2nd Order
	DFD IEC 60268 3rd Order
	DFD IEC 60118 2nd Order
	DFD IEC 60118 3rd Order
	Phase

To select the measurement functions, use the following procedure.

- 1 Press  on the Mode panel to access the Analyzer menu.
- 2 Press **Function 1** and select the first measurement function by pressing the corresponding softkey.

3 Using the U8903A as an Audio Generator and Analyzer

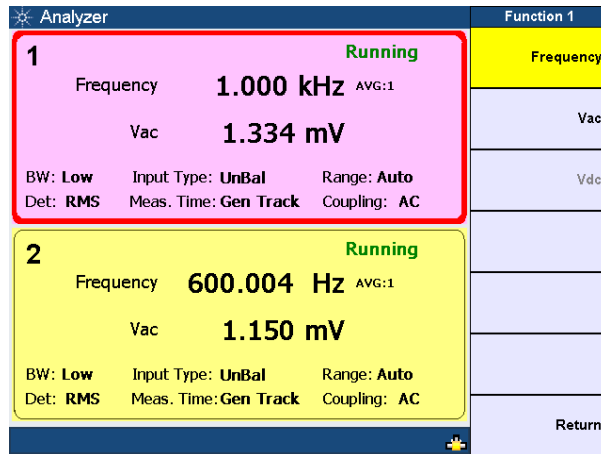

Figure 3-6 Function 1 measurement function selection

3 Press **Function 2** to select the second measurement function.

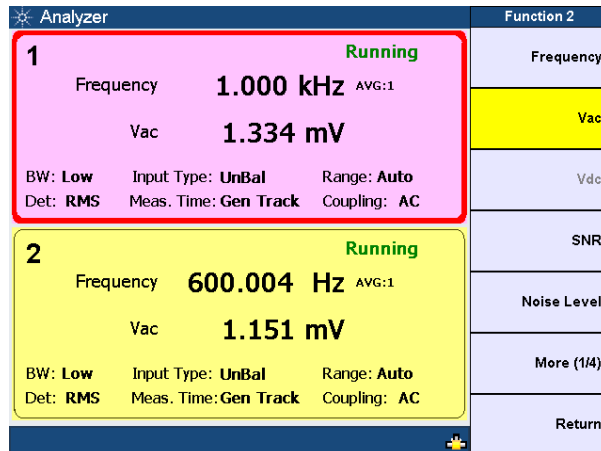

Figure 3-7 Function 2 measurement function selection first page

Analyzer		Bandwidth
1 Running Frequency 1.000 kHz <small>AVG:1</small> Vac 1.334 mV BW: Low Input Type: UnBal Range: Auto Det: RMS Meas. Time: Gen Track Coupling: AC		High
		Low
2 Running Frequency 599.996 Hz <small>AVG:1</small> Vac 1.151 mV BW: Low Input Type: UnBal Range: Auto Det: RMS Meas. Time: Gen Track Coupling: AC		
		Return

Figure 3-8 Function 2 measurement function selection second page

Analyzer		Function 2
1 Running Frequency 999.987 Hz <small>AVG:1</small> Vac 1.334 mV BW: Low Input Type: UnBal Range: Auto Det: RMS Meas. Time: Gen Track Coupling: AC		SMPTE IMD
		DFD 60268 2nd
2 Running Frequency 599.999 Hz <small>AVG:1</small> Vac 1.151 mV BW: Low Input Type: UnBal Range: Auto Det: RMS Meas. Time: Gen Track Coupling: AC		DFD 60268 3rd
		DFD 60118 2nd
		DFD 60118 3rd
		More (3/4)
		Return

Figure 3-9 Function 2 measurement function selection third page

3 Using the U8903A as an Audio Generator and Analyzer

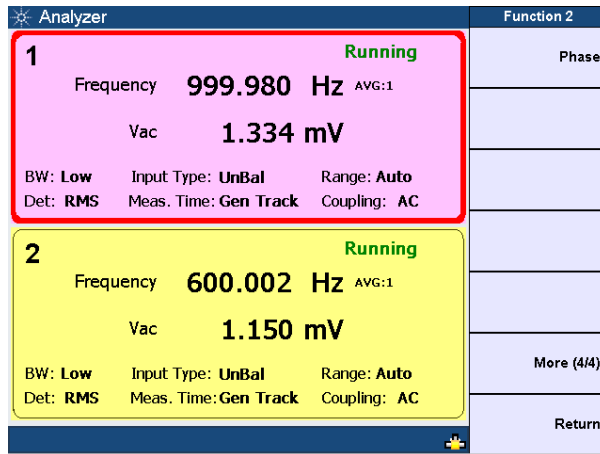

Figure 3-10 Function 2 measurement function selection fourth page

Measurement Examples

Example 1: Generating a sine waveform and measuring its voltage with the analyzer

In this example, you will familiarize yourself with the U8903A generator and analyzer functions by generating a sine waveform from the generator, and using the analyzer to measure its voltage.

Connect the channel 1 output to the channel 1 input using a BNC cable.

To generate a sine waveform with a frequency of 9 kHz and an amplitude of 4 Vrms, perform the following steps.

- 1 Press **Generator** on the Mode panel to access the Generator menu.
- 2 Press **Preset** on the System panel to preset the generator mode to its default settings. Press **Generator** to preset the generator mode.
- 3 Press **Frequency** and set the channel 1 frequency to 9 kHz.
- 4 Press **Amplitude** and set the channel 1 amplitude to 4 Vrms.

After completing the above steps, the U8903A display should look as follows.

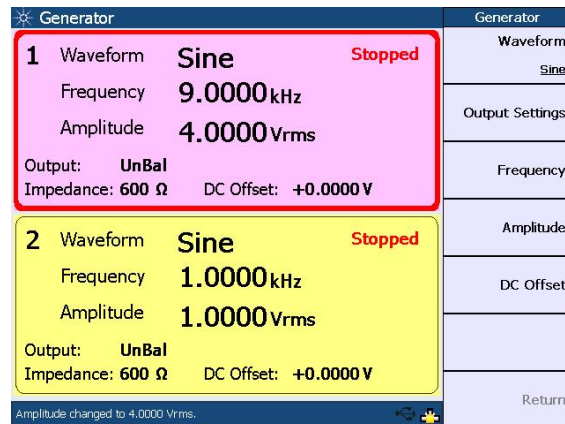





Figure 3-11 Sine waveform configuration

3 Using the U8903A as an Audio Generator and Analyzer

- 5 Press  to start the signal generation on channel 1.

To measure the voltage of the sine waveform, follow the procedure below.

- 1 Press  on the Mode panel to access the Analyzer menu.
- 2 Press  on the System panel to preset the analyzer mode to its default settings. Press **Analyzer** to preset the analyzer mode.
- 3 Press  to allow the U8903A to take continuous readings on channel 1.

You should obtain an AC voltage reading of 4 V for the generated sine waveform, within the tolerance as stated in *Chapter 8, Specifications of the U8903A Audio Analyzer User's Guide*.

NOTE

When the RMS detector is selected, the AC voltage measurement is expressed as an RMS value.

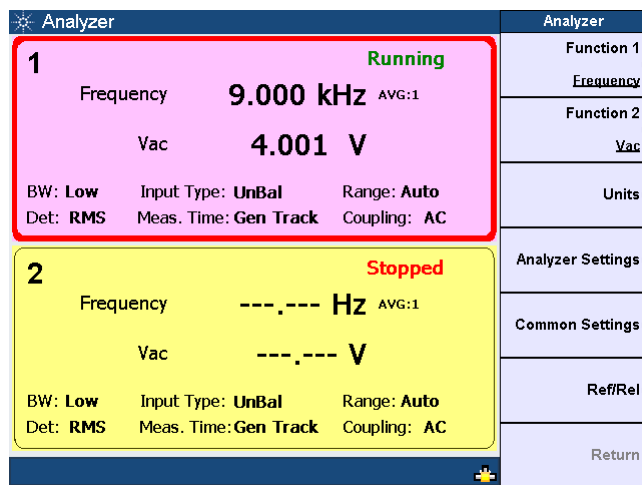

Figure 3-12 Voltage measurement

Example 2: Generating a dual sine waveform and measuring its THD+N Ratio with the analyzer

This example guides you how to generate a dual sine waveform from the U8903A generator and use the analyzer to measure its THD + N Ratio.

Connect the channel 1 output to the channel 1 input using a BNC cable.

To generate a dual sine waveform, perform the following steps.

- 1 Press **Generator** on the Mode panel to access the Generator menu.
- 2 Press **Preset** on the System panel to preset the generator mode to its default settings. Press **Generator** to preset the generator mode.
- 3 Press **Waveform** to access the waveform type menu for channel 1.
- 4 Select **Dual Sine** to access the dual sine waveform menu.
- 5 Press **Dual** to access the dual waveform menu.

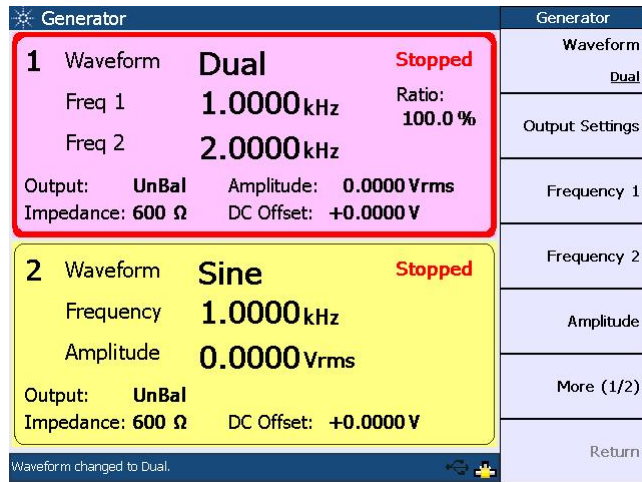

Figure 3-13 Dual waveform menu first page

3 Using the U8903A as an Audio Generator and Analyzer

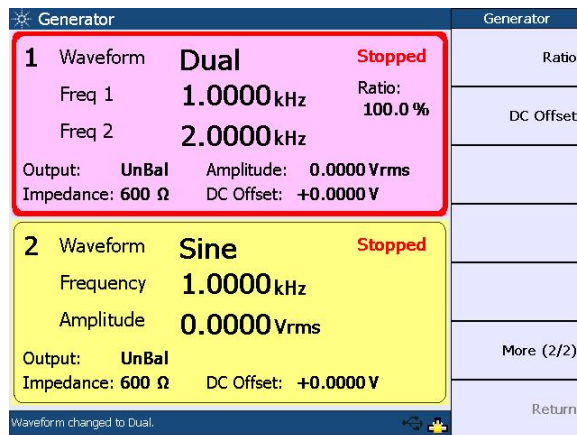

Figure 3-14 Dual waveform menu second page

- 6 Press **Frequency 1** and set the first sinewave component frequency to 5 kHz.
- 7 Press **Frequency 2** and set the second sinewave component frequency to 9 kHz.
- 8 Press **Amplitude** and set the amplitude to 1 Vrms.
- 9 Press **Ratio** and set the amplitude ratio to 1%.

After completing the above steps, the U8903A display should look as follows.

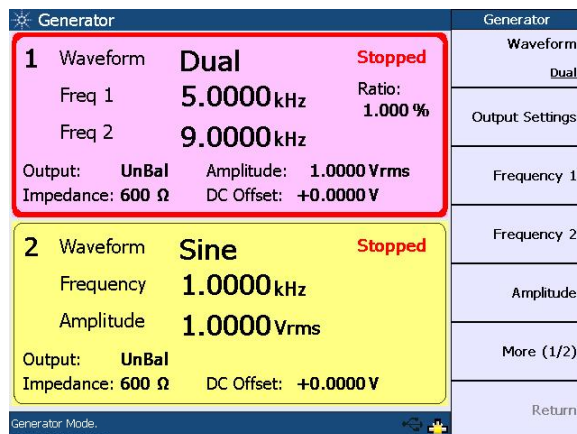





Figure 3-15 Dual sine waveform configuration

10 Press  to start the signal generation on channel 1.

To measure the THD + N Ratio of the dual waveform, use the following procedure.

- 1 Press  on the Mode panel to access the Analyzer menu.
- 2 Press  on the System panel to preset the analyzer mode to its default settings. Press **Analyzer** to preset the analyzer mode.
- 3 Press **Function 2** and select the THD + N Ratio function for channel 1.
- 4 Press  to allow the U8903A to take continuous readings on channel 1.

You should obtain a THD + N Ratio reading of -40 dB for the generated dual waveform, within the tolerance as stated in *Chapter 8, Specifications* of the *U8903A Audio Analyzer User's Guide*.

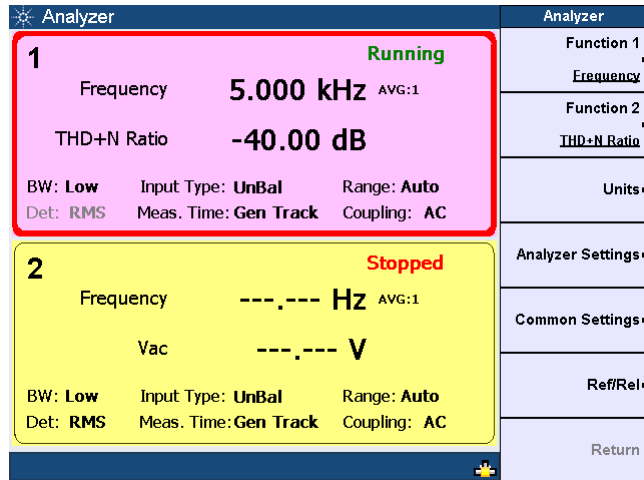





Figure 3-16 THD + N Ratio measurement (amplitude ratio of 1%)

The THD + N measurement returns the ratio of the total harmonic distortion and noise of the signal, with respect to the fundamental amplitude. For a dual sine waveform, this measurement will consider the second frequency component of 9 kHz as a distortion component. An amplitude ratio of 1% between the two frequency components translates to a THD + N reading of -40 dB. Refer to the *U8903A Audio Analyzer User's Guide* for more information on the THD + N measurement theory.

Using the same channel 1 dual waveform configuration of the generator mode, set the amplitude ratio to 0.1%. Press  to start the signal generation on channel 1.

On the same Analyzer menu where you have measured the THD + N Ratio, press  to acquire the THD + N Ratio reading for the 0.1% amplitude ratio. You should obtain a THD + N reading of -60 dB, within the tolerance as stated in the *U8903A Audio Analyzer User's Guide*. An amplitude ratio of 0.1%, or 0.001 between the two frequency components is equivalent to a THD + N reading of -60 dB.

Return to the generator mode and set the waveform type to normal single sine for channel 1 by pressing **Waveform > Sine**. Set the amplitude to 1 Vrms. Press  to start the signal generation on channel 1.

On the same Analyzer menu where you have measured the THD + N Ratio, press  to acquire the THD + N Ratio reading for the generated single sine waveform. The THD + N reading obtained is the actual THD + N measurement on the sine waveform generated by the U8903A. This reading should be lower than -101 dB, which is the residual THD + N specification as given in *Chapter 8, Specifications of the U8903A Audio Analyzer User's Guide*.

On the same Analyzer menu, apply the 20 kHz low pass filter by pressing **Analyzer Settings > Filter > LPF > 20 kHz**. Press  to obtain the THD + N Ratio reading. You will observe that the THD + N reading is even better now as the distortion and noise above 20 kHz are filtered out.

Example 3: Generating a variable phase waveform and measuring its phase difference

This example shows you how to generate a variable phase waveform from the U8903A generator and use the analyzer to measure its phase difference.

Connect the channel 1 output to the channel 1 input, and channel 2 output to the channel 2 input using the BNC cables.

To generate a variable phase waveform, perform the following steps.

- 1 Press **Generator** on the Mode panel to access the Generator menu.
- 2 Press **Preset** on the System panel to preset the generator mode to its default settings. Press **Generator** to preset the generator mode.
- 3 Select channel 2 using the arrow keys.
- 4 Press **Waveform** to access the waveform type menu.
- 5 Select **Variable Phase** to access the variable phase waveform menu.

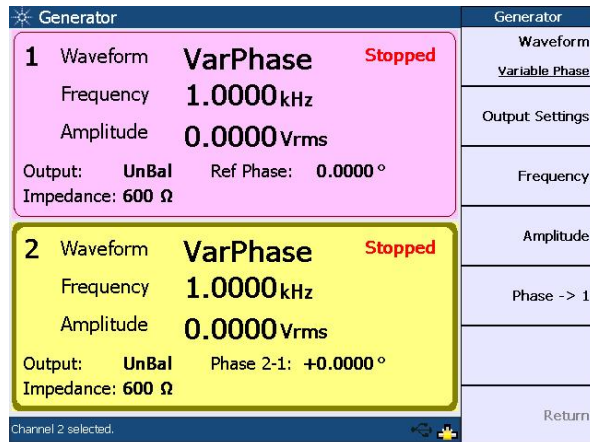

Figure 3-17 Variable phase waveform menu

- 6 Press **Frequency** and set the frequency to 5 kHz.
- 7 Press **Amplitude** and set the amplitude to 2 Vrms.
- 8 Press **Phase -> 1** and set the phase with reference to channel 1 as 90°.
- 9 Select channel 1 and set the amplitude to 1 Vrms.

3 Using the U8903A as an Audio Generator and Analyzer

After completing the above steps, the U8903A display should look as follows.

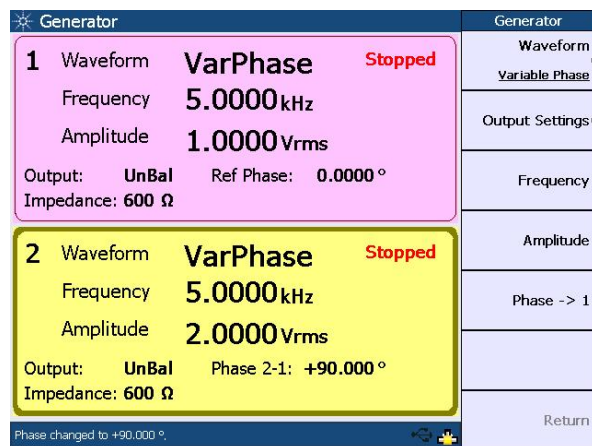





Figure 3-18 Variable phase waveform configuration

10 Press  to start the signal generation for channels 1 and 2 simultaneously.

To measure the phase difference of the variable phase waveform, follow the procedure below.

- 1 Press  on the Mode panel to access the Analyzer menu.
- 2 Press  on the System panel to preset the analyzer mode to its default settings. Press **Analyzer** to preset the analyzer mode.
- 3 At channel 1, press **Function 2** and select the phase measurement function. Channel 1 becomes the reference channel and channel 2 will measure the phase with reference to channel 1.
- 4 Press  for both channels to allow the U8903A to take continuous readings.

You should obtain a phase reading of 90 ° with reference to channel 1 for the generated variable phase waveform, within the tolerance as stated in *Chapter 8, Specifications of the U8903A Audio Analyzer User's Guide*.

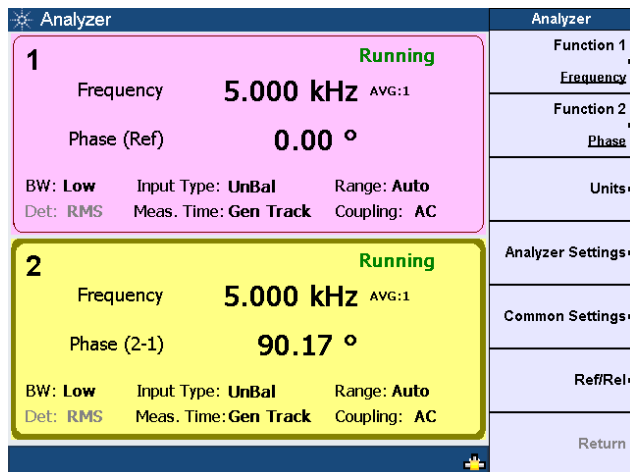



Figure 3-19 Phase difference measurement

Example 4: Measuring crosstalk

In this example, you will first simulate a high level of crosstalk using signals with similar frequencies on both channels. After that, the actual residual crosstalk performance of the U8903A will be measured.

This example is a follow-up of Example 3. Connect the channel 1 output to the channel 1 input, and channel 2 output to the channel 2 input using the BNC cables. Continue with the following steps:

- 1 Return to the generator mode where you have set the variable phase waveform and select channel 1 using the arrow keys.
- 2 Press **Amplitude** and set the amplitude to 0.02 Vrms.
- 3 Press  to start the signal generation for channels 1 and 2 simultaneously.
- 4 On the same Analyzer menu where you have performed the phase measurement, select channel 2 using the arrow keys.
- 5 Press **Function 2** and select the crosstalk (channel driven) measurement function. Channel 2 becomes the reference channel.
- 6 Press  for channels 1 and 2 to allow the U8903A to take continuous readings.

NOTE

The reference channel always displays a value of 0 dB or 100% for all crosstalk measurements.

You should obtain a crosstalk result of around -40 dB.

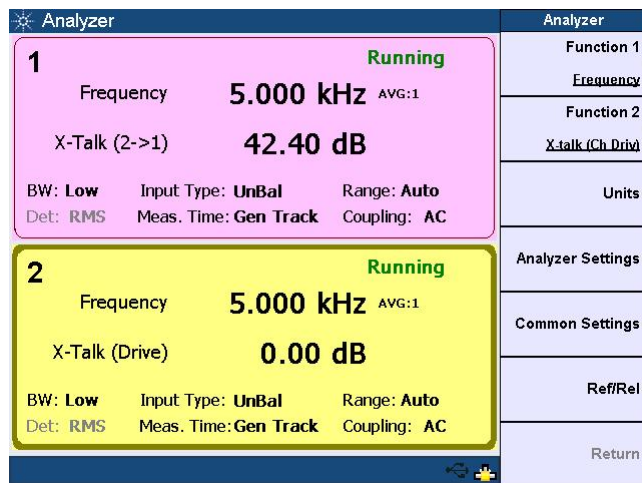



Figure 3-20 Crosstalk (channel driven) measurement

This crosstalk measurement quantifies the signal leakage from channel 2 to channel 1. The crosstalk algorithm first measures the amplitude of the wanted signal, in this case the 5 kHz, 2 Vrms sine waveform on channel 2 (driven channel). It then measures the amplitude of the unwanted 5 kHz component on channel 1 (measured channel).

In this example, a high level of crosstalk is simulated by intentionally injecting a 5 kHz, 0.02 Vrms sine waveform into channel 1. The algorithm calculates the crosstalk value as 0.02 Vrms/2 Vrms, or 0.01. In the log scale, this is equivalent to -40 dB.

You will now measure the actual crosstalk performance of the U8903A. To do this, the signal that you feed into the measured channel must not be the same frequency as the driven channel. Return to the generator mode and set the waveform type to normal single sine for channels 1 and 2 by pressing **Waveform > Sine**. Use the same configuration as the variable phase waveform for frequency and amplitude for both channels. Change the channel 1 frequency to 15 kHz.

Press  to start the signal generation for channels 1 and 2 simultaneously. The U8903A display should look as follows.

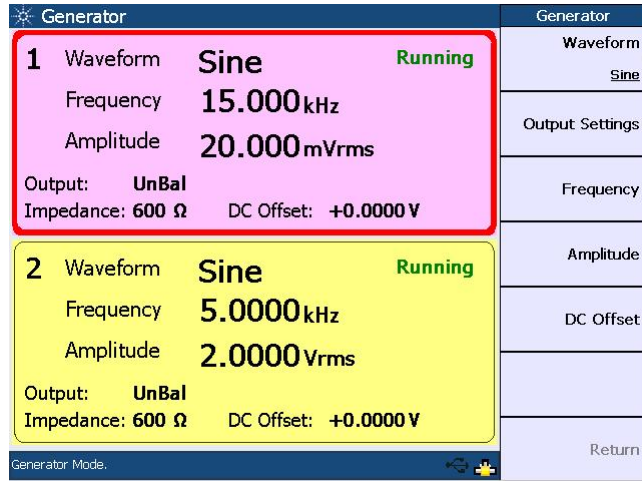



Figure 3-21 Sine waveform configuration

On the same Analyzer menu where you have measured the crosstalk from channel 2 to 1, press  for both channels to allow the U8903A to take continuous readings. You should obtain a crosstalk result of lower than -100 dB for the generated sine waveform. This is the actual residual crosstalk of the U8903A caused by the 5 kHz signal from channel 2 coupling into channel 1 inside the U8903A. You will observe the same results even if you turn off the channel 1 generator or disconnect the BNC cable from channel 1.

3 Using the U8903A as an Audio Generator and Analyzer

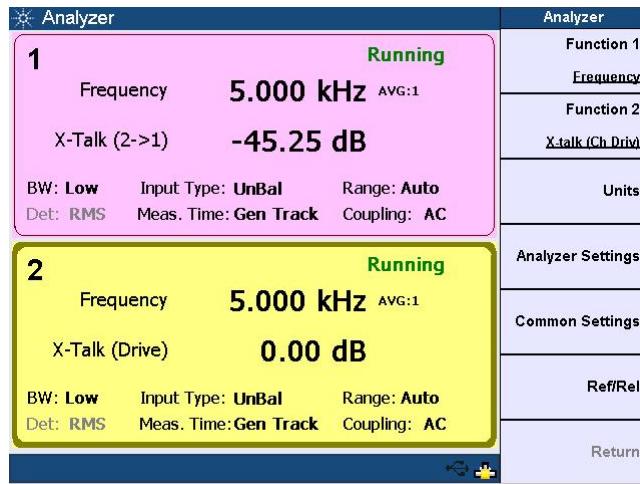

Figure 3-22 Crosstalk (channel driven) measurement

4 Performing Frequency and Time Domain Analysis and Sweep

Performing Frequency and Time Domain Analysis	60
Performing Sweep	65
Using the Graph Functions	71

This chapter describes how to configure the U8903A graph settings for frequency and time domain analysis. The sweep configuration as well as graph functions are also described in this chapter.

Performing Frequency and Time Domain Analysis

The U8903A graph mode displays the waveform in the time or frequency domain. In the time domain mode, the steps involved are acquiring the data and displaying the results. On the other hand, the steps for the frequency domain mode consist of acquiring the data, performing the FFT operation, and processing the results for graphing.

To access the frequency or time domain mode, press **Frequency Domain** or **Time Domain** on the Mode panel respectively.

You may generate the graph by pressing **Run/Stop** once you have configured the graph settings.

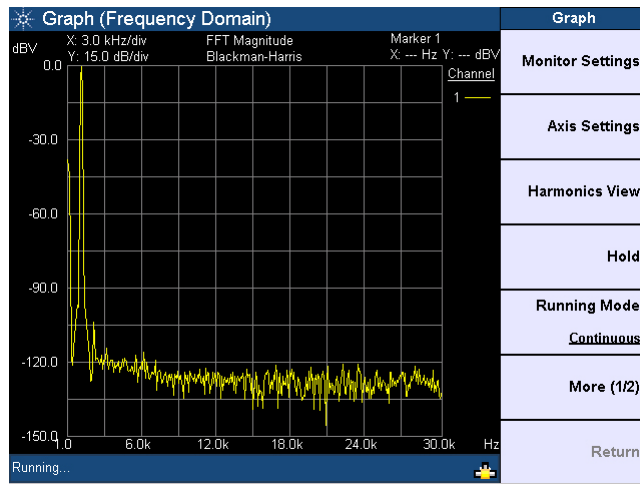

Figure 4-1 Frequency domain mode

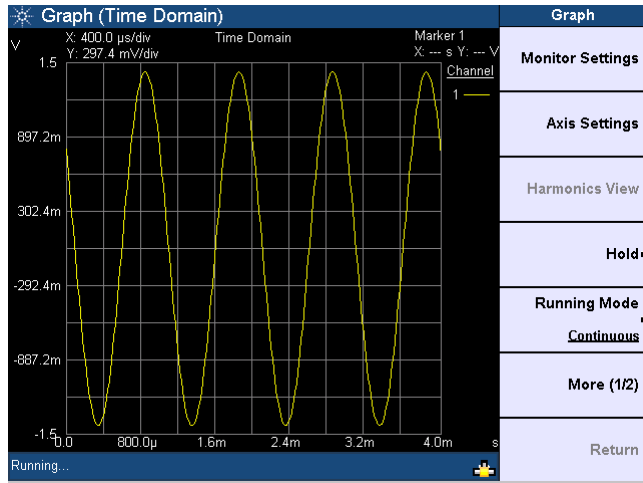

Figure 4-2 Time domain mode

Use the following procedure to configure the graph in the frequency or time domain.

- 1 Press **Monitor Settings** to access the graph display configuration page.

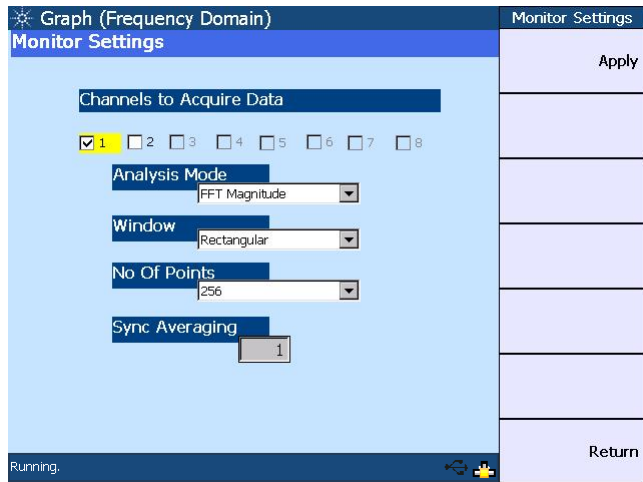

Figure 4-3 Monitor settings configuration

4 Performing Frequency and Time Domain Analysis and Sweep

On the Monitor Settings page, you may select the channel(s) to acquire the graph data for display. The valid channels are channels 1 and 2, while channels 3 to 8 will only be available in future releases.

The analysis mode allows you to set the graph display to either time domain, frequency domain (magnitude), or frequency domain (phase). The window selection comprising Rectangular, Hann, Hamming, Blackman-Harris, Rife-Vincent 1 and 3, and Flattop, are only applicable in the frequency domain and will not affect the time domain analysis.

You can also select how many points of the data record to acquire and display from 256 to 32768. The synchronous averaging setting provides selectable values of 1 to 64, however, this setting is only applicable when the trigger source is set to the channel-based trigger. To configure the trigger settings, refer to Step 2.

Press **Apply** once you have configured the monitor settings.

- 2 Press **Axis Settings** to configure the graph X-axis and Y-axis values and spacing. Press **Apply** and the graph will be redrawn to reflect the settings you have configured. You can also choose to perform autoscaling by pressing **Auto Scale**, **Auto Scale X**, and **Auto Scale Y**.

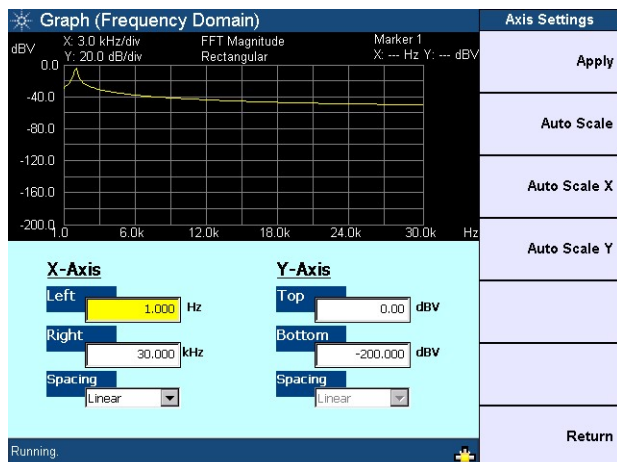

Figure 4-4 Axis settings configuration

- 3 Press **Input Settings** in the frequency or time domain mode to configure the input and trigger settings.

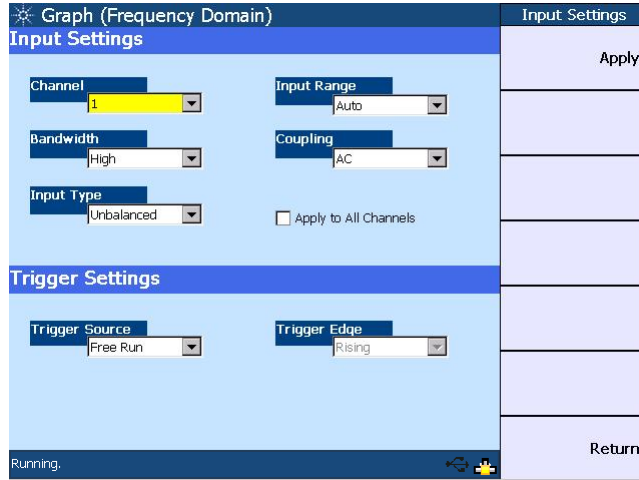

Figure 4-5 Input and trigger settings configuration

For the input settings, you may select the channel to be configured, measurement bandwidth, input connection and range, as well as coupling. The trigger settings section allows you to select the trigger source and trigger edge. Press **Apply** once you have configured the input and trigger settings.

To display the level of each signal harmonic component of the frequency domain analysis, press **Harmonics View**.

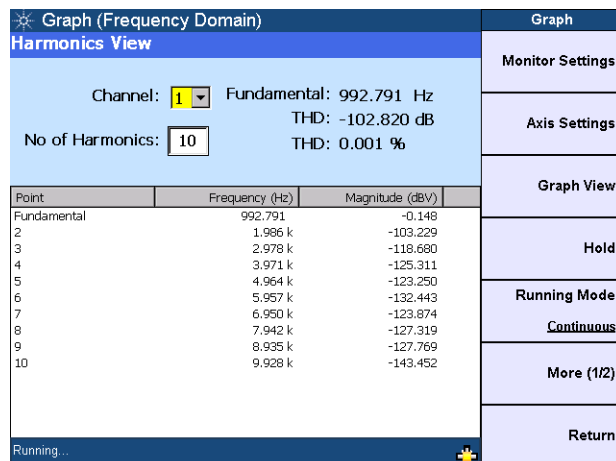



Figure 4-6 Harmonics display

The Harmonics View feature is not applicable in the time domain mode. You may select the channel and enter the number of harmonic component levels to be displayed. The signal harmonic components data will be listed in the table.

The hold function sets the graph hold configuration type to be used to update the graph data for channels 1 and 2. You can set the hold configuration to none, maximum, or minimum.

You can choose to allow the graph to run continuously by pressing **Running Mode > Continuous**. The **Running Mode > Single** function enables you to perform a single acquisition of the graph data each time  is pressed.

You may save the graph points to a file by pressing **Save Pts to File**. The File Manager menu will be launched to allow you to save the graph points. Refer to [Chapter 5, "File Maintenance"](#) on page 75 for more details on the File Manager.

Performing Sweep

In the Sweep mode, a generator parameter such as frequency, amplitude, or phase is varied across a certain range. At each point of the sweep, an analyzer measurement is made.

To access the Sweep menu, press **Sweep** on the Mode panel. You may initiate the sweep by pressing **Run/Stop**. The sweep parameter is displayed on the horizontal axis, while the sweep measurement is displayed on the vertical axis.

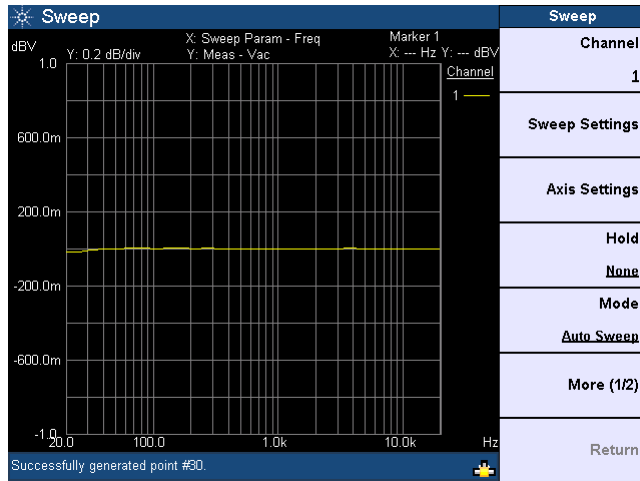

Figure 4-7 Sweep menu first page

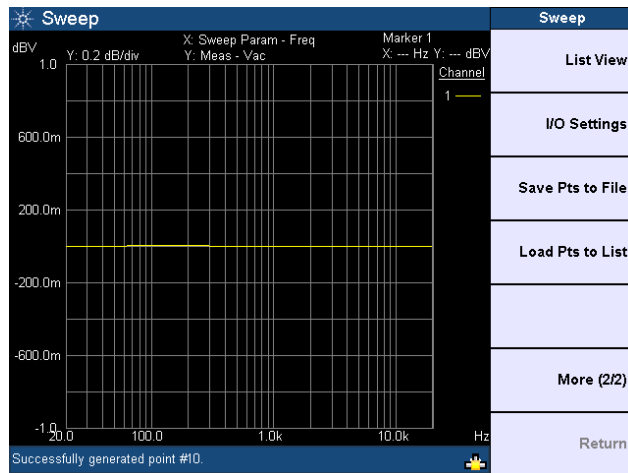

Figure 4-8 Sweep menu second page

Use the following procedure to configure the sweep.

- 1 Press **Channel** to select the channel to perform sweep.

NOTE

You must not select channel 1 as the sweep channel if the generator function is variable phase, as channel 1 is the reference channel for variable phase.

- 2 Press **Sweep Settings** to access the sweep configuration page. You may select the waveform type and sweep parameter, configure the start and stop points, step size, number of points, and spot values, as well as select the spacing, dwell time, and measurement function. The sweep parameter selection and spot panel will change according to the selected waveform type. Press **Apply** once you have configured the sweep settings.
If you have selected the Auto List and Manual List sweep modes, the sweep start and stop points as well as step size and number of sweep points will not be applicable.

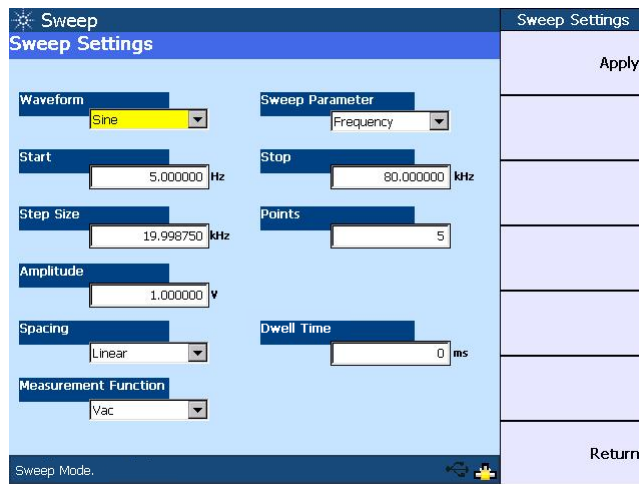

Figure 4-9 Sweep settings configuration

NOTE

- Multitone and arbitrary waveform functions are not applicable in the sweep mode.
- Amplitude values set on the sweep settings page are assumed to be RMS values.

- 3** Press **Axis Settings** to configure the graph X-axis and Y-axis values and spacing. Press **Apply** and the graph will be redrawn to reflect the settings you have configured. You can also choose to perform autoscaling by pressing **Auto Scale**, **Auto Scale X**, and **Auto Scale Y**.

4 Performing Frequency and Time Domain Analysis and Sweep



Figure 4-10 Axis settings configuration

- 4 Press **Hold** to set the sweep hold configuration type to be used to update the graph data. You can set the hold configuration to none, maximum, or minimum.
- 5 Press **Mode** to select the sweep type as either Auto Sweep, Auto List, Manual Sweep, or Manual List. For the Auto List and Manual List sweep modes, you may load the sweep points from a file or modify the points directly in [List View](#).
- 6 On the Sweep menu, press **I/O Settings** to configure the input and output settings. For the input settings, you may select the measurement bandwidth, input range and connection, AC/DC coupling, and measurement time. The output settings section allows you to select the output connection and impedance. Press **Apply** once you have configured the input and output settings.

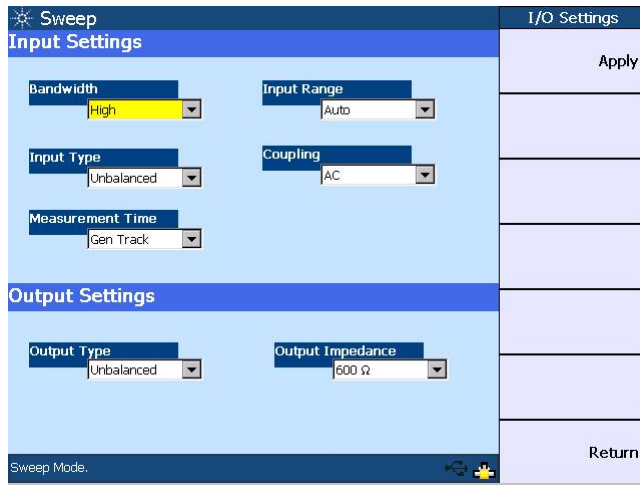

Figure 4-11 I/O settings configuration

To view the sweep points in list form, press **List View**. You may add sweep points below the list by pressing **Add Point**. To edit the sweep parameter value of a selected point, press **Edit Point**. To delete points, press **Delete Point**.

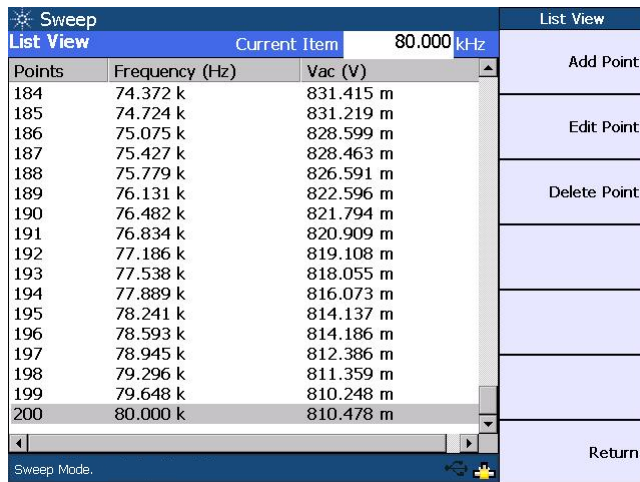



Figure 4-12 List View

4 Performing Frequency and Time Domain Analysis and Sweep

You may save the sweep points to a file by pressing **Save Pts to File**. To load the sweep points from a file to a list, press **Load Pts to List**. The File Manager will be launched to allow you to save or load the sweep points. Refer to [Chapter 5, "File Maintenance"](#) on page 75 for more details on the File Manager.

Using the Graph Functions

You may perform peak searching, configure the markers, select the marker position on the graph, or maximize the graph view to the full display size by pressing the corresponding key on the Graph panel.

- To access the peak search function, press  on the Graph panel.

This function allows you to place a marker on the peak or minimum of the graph. You can set the threshold level that the marker can identify as a peak or minimum on the graph. If the trace is above the threshold level, it will be identified as a peak, whereas the trace below the threshold level will be identified as a minimum. Use the knob on the U8903A front panel to move the threshold level along the plot. The X-axis and Y-axis values of the marker will be displayed at the top right of the graph based on its position.

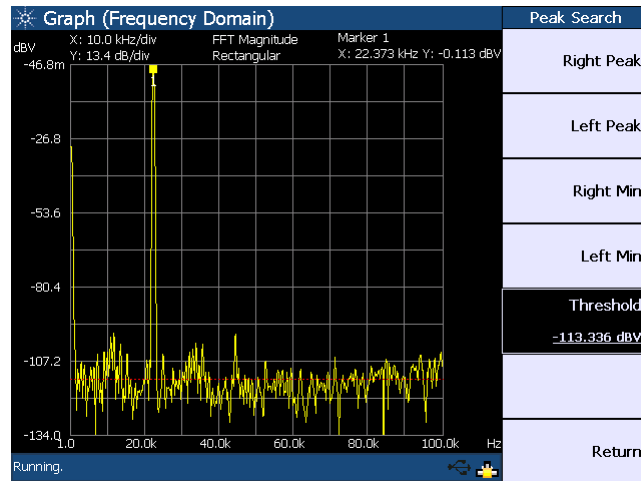

Figure 4-13 Peak Search menu

- To access the marker functions, press **Marker** on the Graph panel.

On the Marker menu, you may set the current and reference markers to be placed on the graph by pressing **Current Marker** and **Refer to Marker** respectively. Press **Marker State > On** to display the markers on the graph or **Marker State > Off** to remove the markers from the graph.

Use the knob on the U8903A front panel to move the markers along the graph plot. Press **Movement > Single** to move only the current marker or **Movement > Pair** to move both the current and reference markers. Press **Show Table** to display the measurement data of the selected marker(s) in a table.

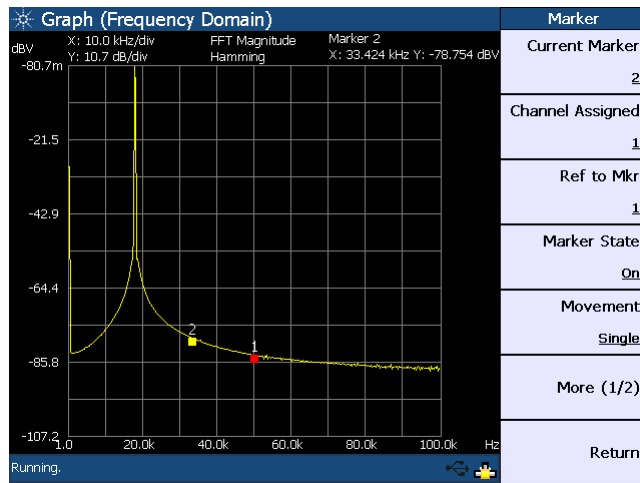

Figure 4-14 Marker menu first page

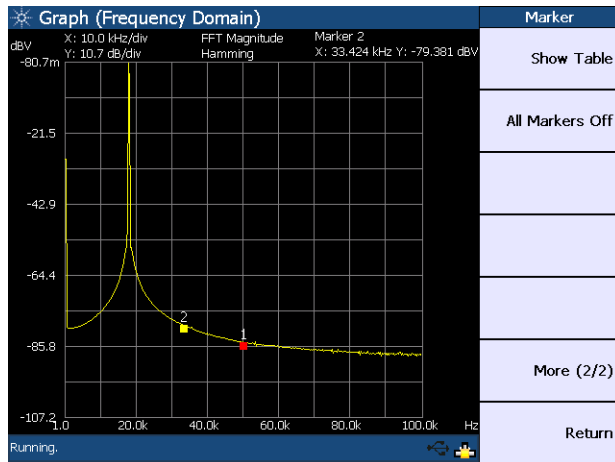

Figure 4-15 Marker menu second page

- To view a section of the graph based on the current marker position, press



on the Graph panel.

You may configure the graph area to be displayed by positioning the current marker at either the center, start, or stop point of the graph plot. Press **Marker** $\Delta \rightarrow$ **Span** to display the area between the current marker and reference marker.

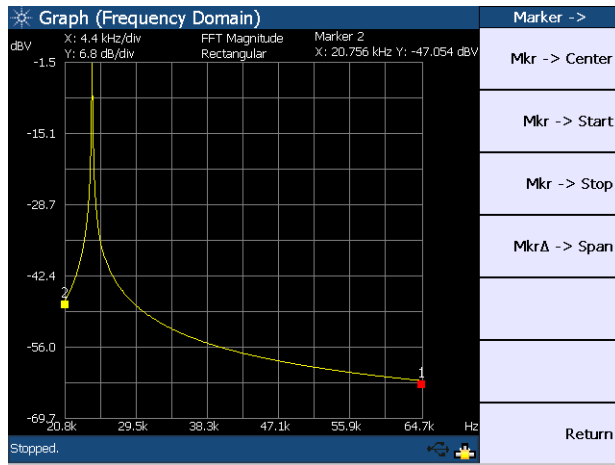



Figure 4-16 Marker -> menu

4 Performing Frequency and Time Domain Analysis and Sweep

- To maximize the graph view to the full display size, press  on the Graph panel. To exit the full screen mode, press any key on the U8903A front panel.

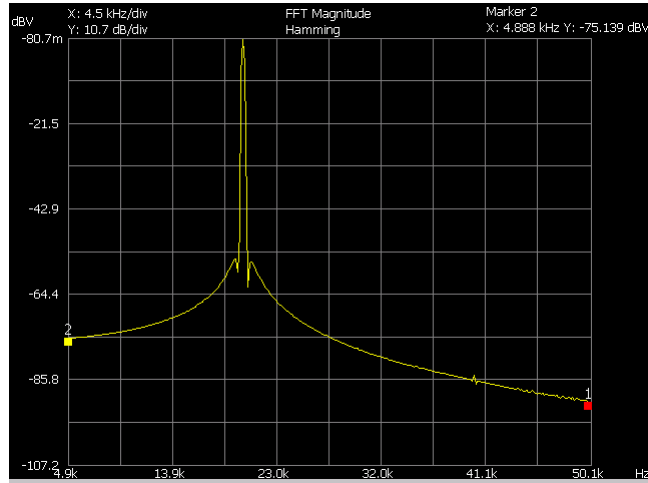

Figure 4-17 Full screen

5 File Maintenance

Saving the Instrument State to a File 76

Recalling the Instrument State from a File 77

This chapter explains how to save and recall the instrument state as well as import or export a file.

Saving the Instrument State to a File

You have the option to save the current U8903A state to a file in either the U8903A internal memory or a USB external flash storage.

To save the U8903A state, press **Save** on the System panel. When **Save** is pressed in the sweep, analyzer, or generator mode, you may select either the selected channel or whole module to save the U8903A state. When **Save** is pressed in the graph mode, you can only select the whole module to save the U8903A state. The File Manager will be launched once you have made your selection.

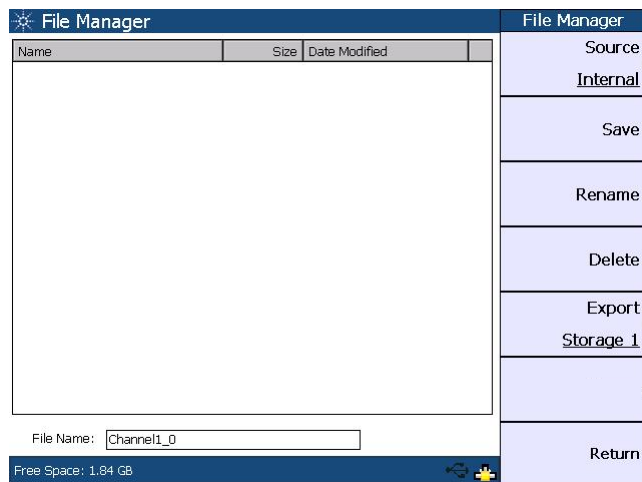

Figure 5-1 File Manager menu for saving the U8903A state

Set the storage location for your file by pressing **Source** and select either the U8903A internal memory or a USB external flash storage before saving.

To save the file, press **Save**. To delete a file, press **Delete**. You can change a selected file name by pressing **Rename**. To export a file from the U8903A internal memory to a USB external flash storage, press **Export** and select the desired USB external flash storage.

Recalling the Instrument State from a File

To recall a saved U8903A state from a file in either the U8903A internal memory or a USB external flash storage, press **Recall** on the System panel to display the File Manager menu as follows.

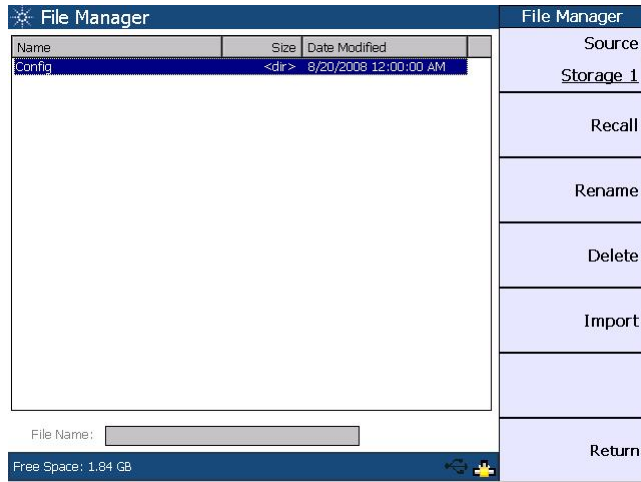

Figure 5-2 File Manager menu for recalling the U8903A state

Press **Source** to select a saved U8903A state file in either the U8903A internal memory or a USB external flash storage. When you have selected a state file, pressing **Recall** will display a Recall page. For single channel state file, the Recall page allows you to select the channel(s) to apply the settings. For module state file except graph, the Recall page allows you to select which channel settings to be applied. As there are no multiple channel settings in the graph state file, channel selection is not applicable in its Recall page. For more information, refer to the *U8903A Audio Analyzer Instrument Help File*.

To import a file from a USB external flash storage to the U8903A internal memory, press **Source** and select the USB external flash storage. Select the desired file and press **Import**.

THIS PAGE HAS BEEN INTENTIONALLY LEFT BLANK.

Appendixes

Generator Menu Tree	80
Analyzer Menu Tree	83
Time Domain and Frequency Domain Menu Trees	86
Sweep Menu Tree	87
System Menu Tree	88

Generator Menu Tree

The generator function menu tree for Sine, Variable Phase, and Dual Sine waveforms is shown below.

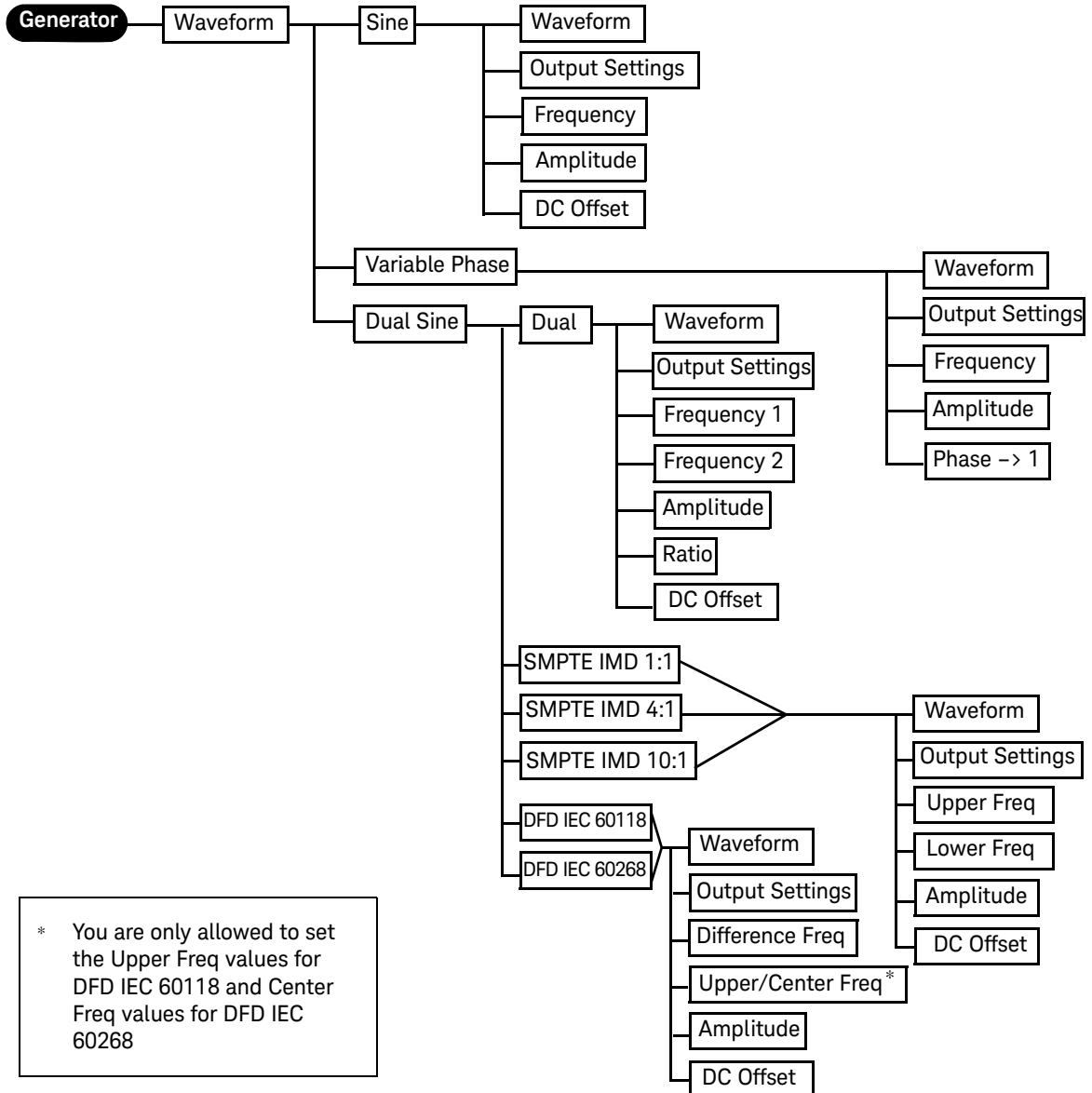

* You are only allowed to set the Upper Freq values for DFD IEC 60118 and Center Freq values for DFD IEC 60268

The following figure shows the generator function menu tree for waveforms consisting of Noise, DC, Multitone, Square, and Arbitrary.

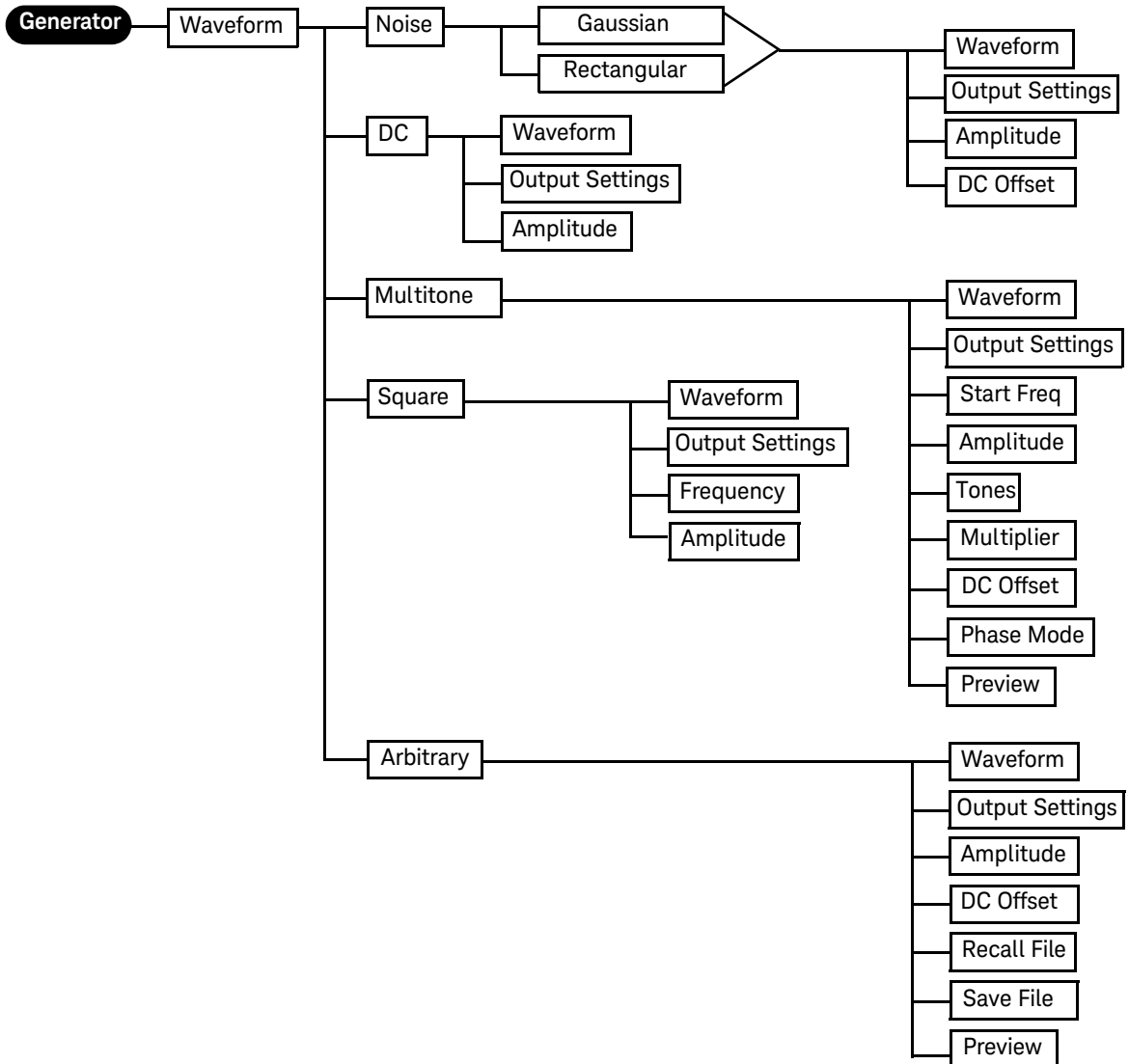

The generator function menu tree for Output Settings, Frequency, Amplitude, and DC Offset is shown as follows.

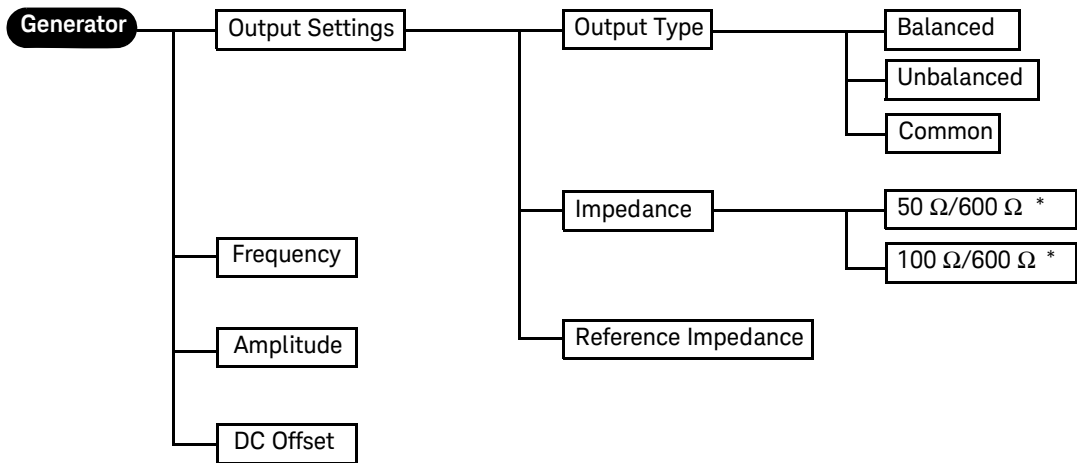

* For Balanced or Common mode output connection, impedance selection is 100 Ω and 600 Ω.
 For Unbalanced output connection, impedance selection is 50 Ω and 600 Ω.

Analyzer Menu Tree

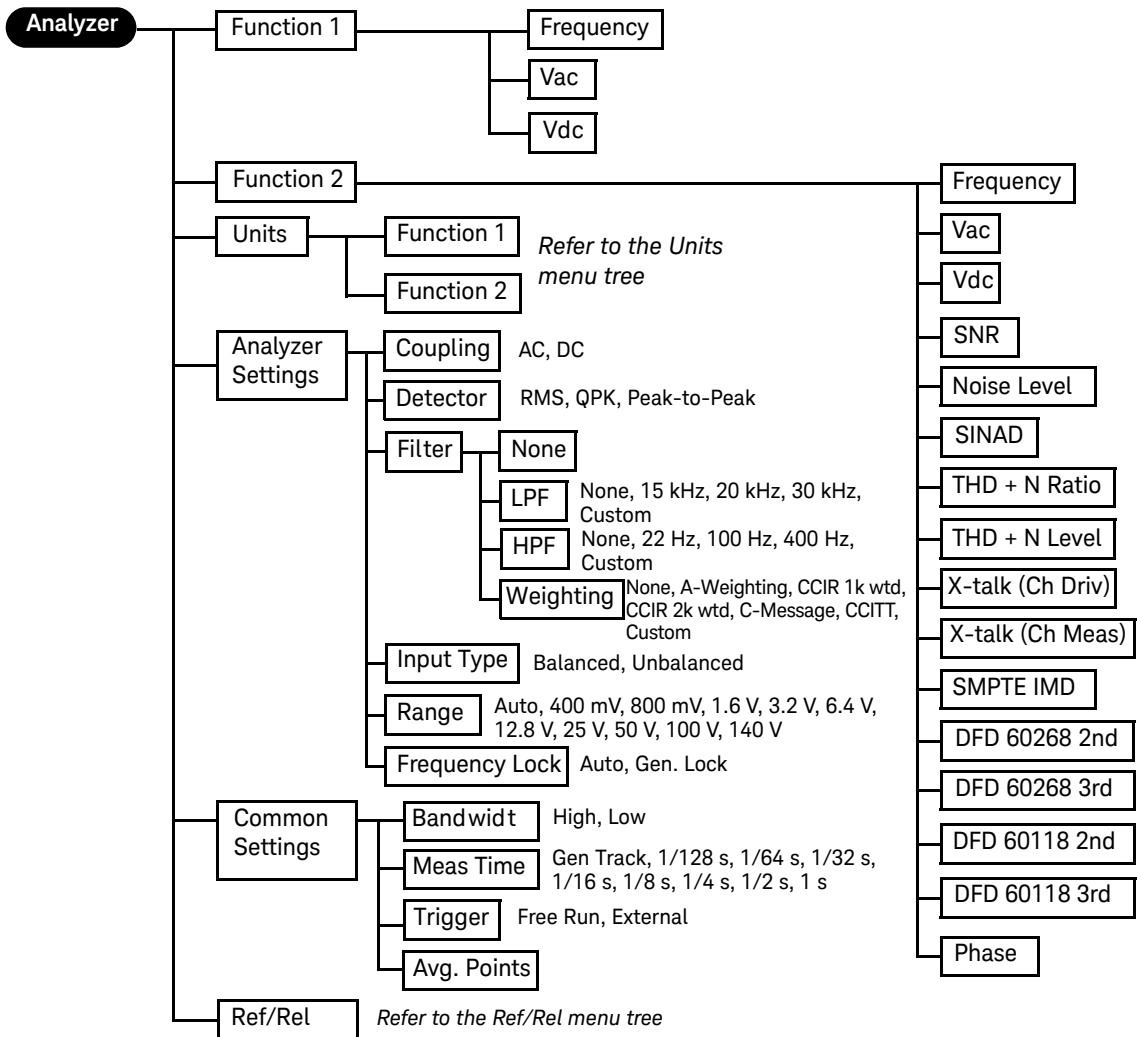

The analyzer function menu tree for Units is shown as follows.

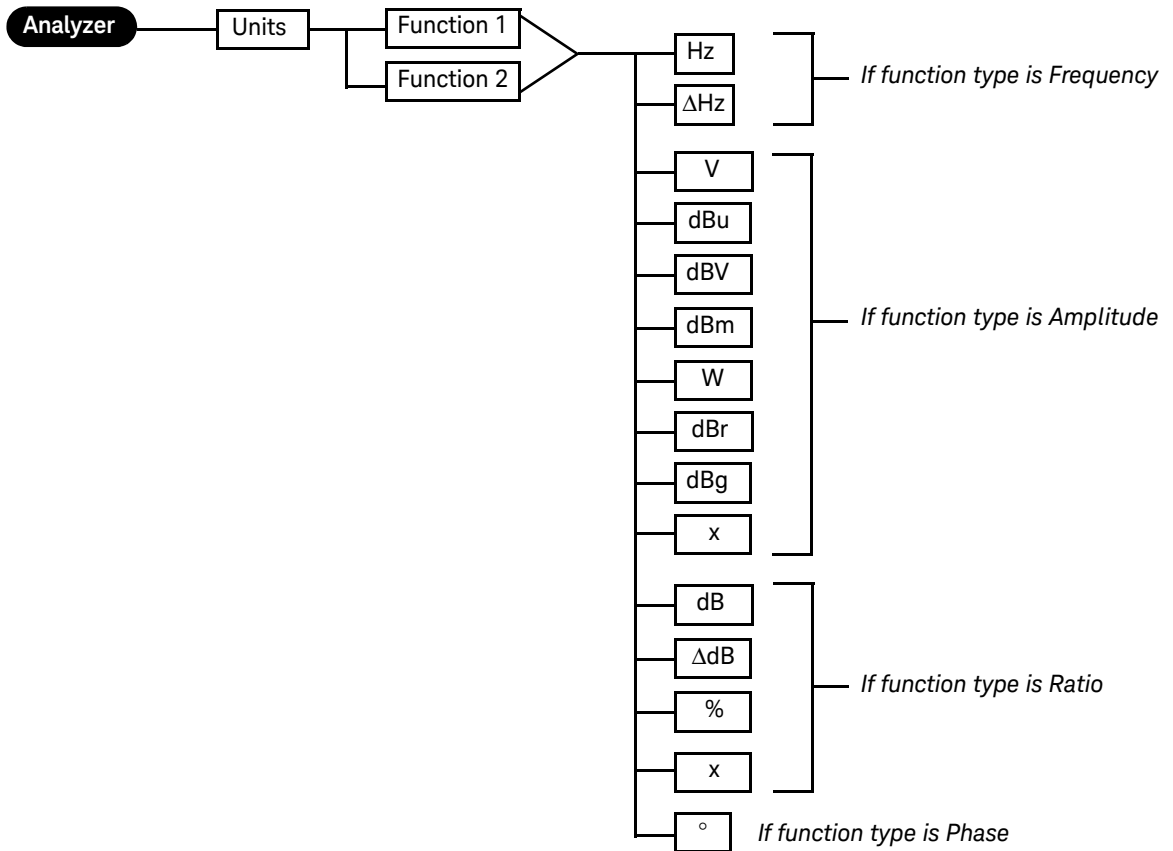

The analyzer function menu tree for Ref/Rel is shown as follows.

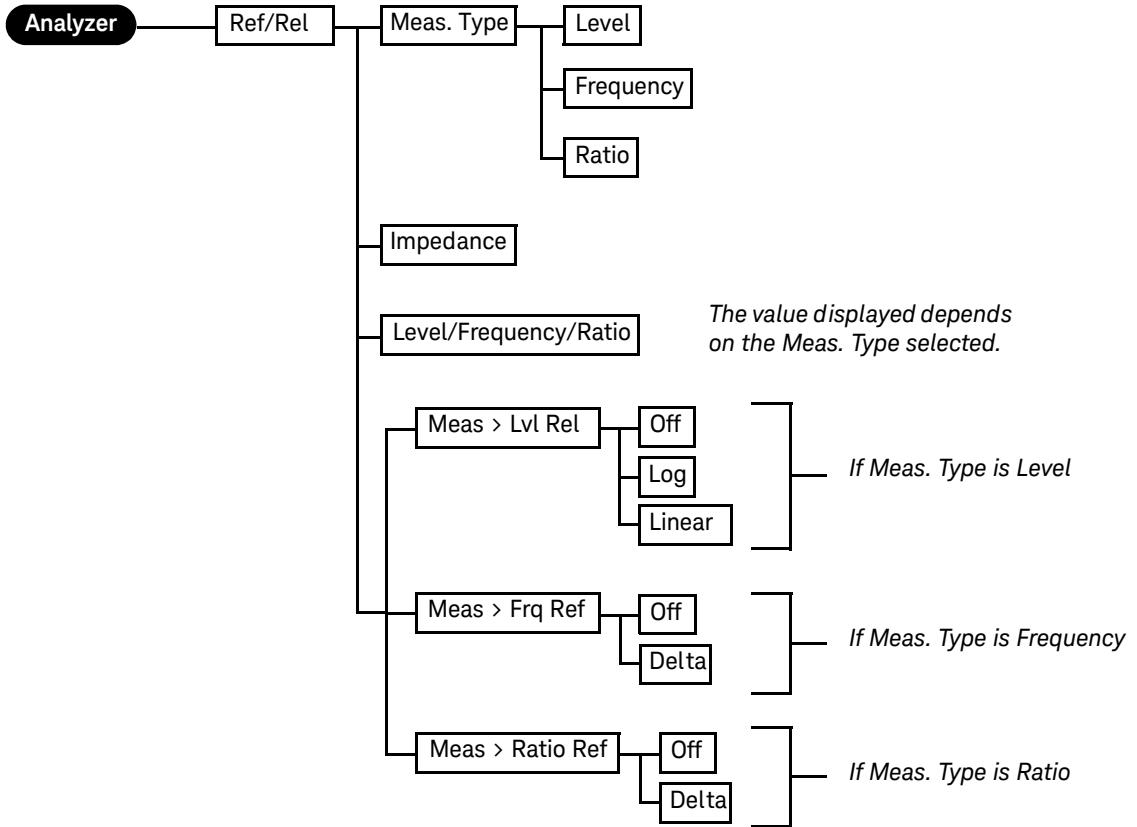

Time Domain and Frequency Domain Menu Trees

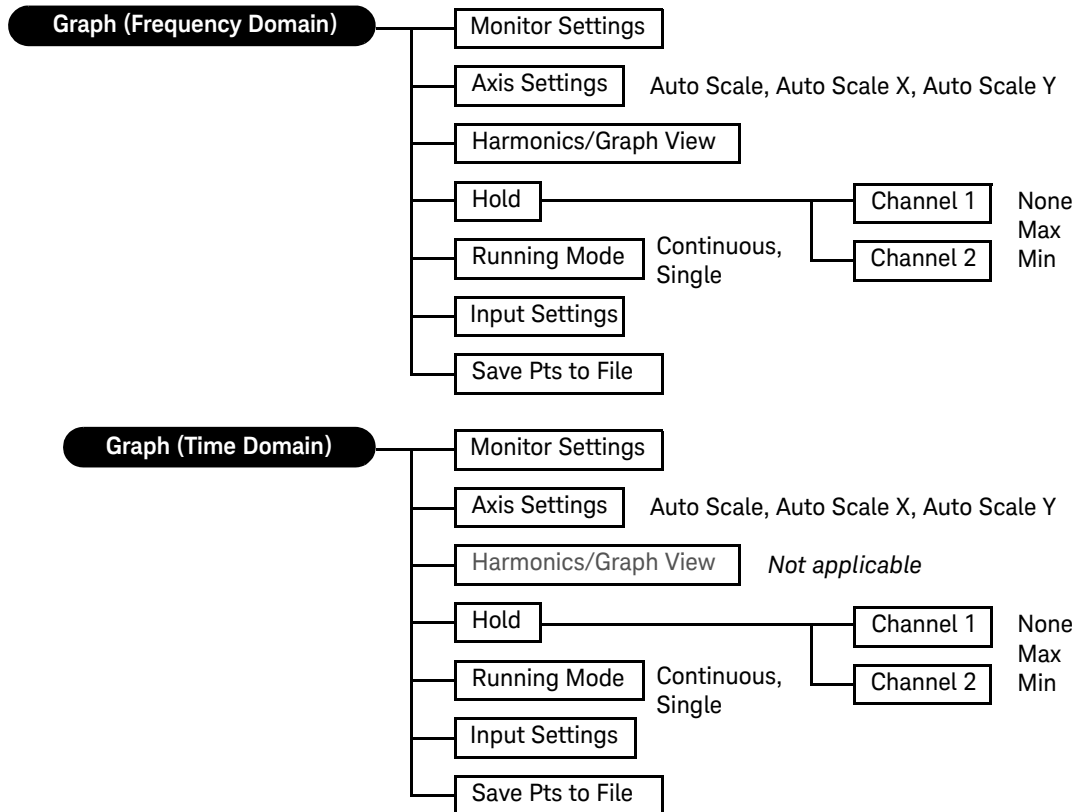

Sweep Menu Tree

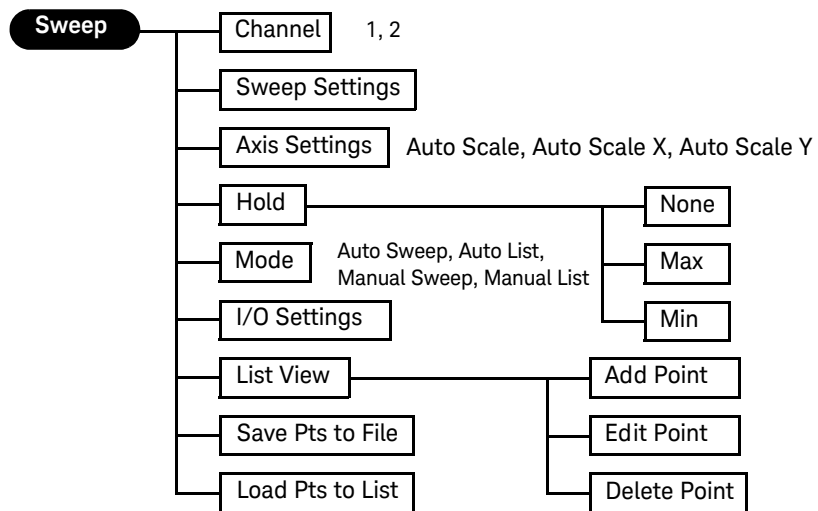

System Menu Tree

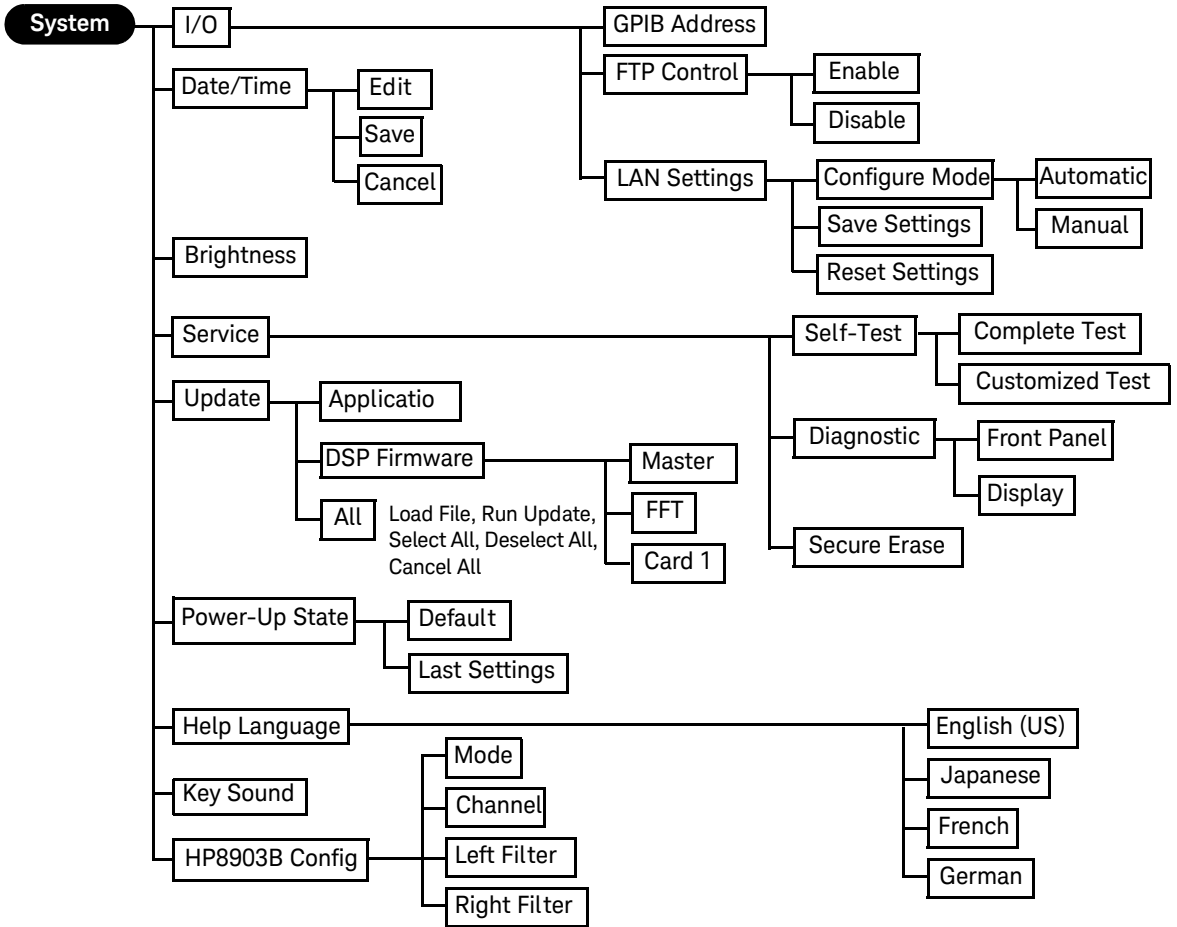



This information is subject to change without notice. Always refer to the Keysight website for the latest revision.

© Keysight Technologies 2009–2016
Edition 7, April 1, 2016

Printed in Malaysia



U8903-90006

www.keysight.com